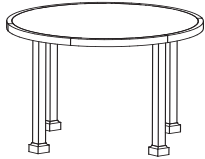
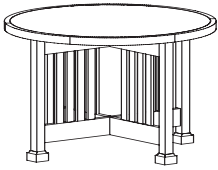
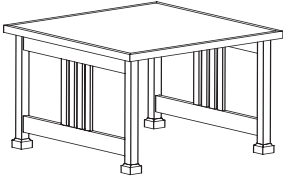
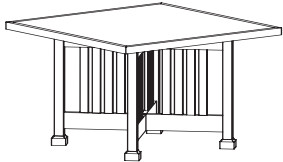

# AGATI

## FRYE COLLECTION

### STUDY TABLES

	DESCRIPTION	ITEM NO	SIZE	STANDARD LIST
	Round Study Table with edgeband, 4 wood legs, wood feet.	<b>Red Oak</b>		
		FRY-TBL-42-30-RO	42 Dia. 30h	
		FRY-TBL-48-30-RO	48 Dia. 30h	
		<b>Cherry</b>		
		FRY-TBL-42-30-C	42 Dia. 30h	
		FRY-TBL-48-30-C	48 Dia. 30h	
		<b>Maple</b>		
		FRY-TBL-42-30-M	42 Dia. 30h	
		FRY-TBL-48-30-M	48 Dia. 30h	
	Round Study Table with edgeband, X-base with 4 slat detail, wood feet.	<b>Red Oak</b>		
		FRY-TBX-48-30-RO	48 Dia. 30h	
		FRY-TBX-54-30-RO	54 Dia. 30h	
		FRY-TBX-60-30-RO	60 Dia. 30h	
		<b>Cherry</b>		
		FRY-TBX-48-30-C	48 Dia. 30h	
		FRY-TBX-54-30-C	54 Dia. 30h	
		FRY-TBX-60-30-C	60 Dia. 30h	
		<b>Maple</b>		
FRY-TBX-48-30-M	48 Dia. 30h			
FRY-TBX-54-30-M	54 Dia. 30h			
FRY-TBX-60-30-M	60 Dia. 30h			
	Square Study Table with edgeband, Stretcher base with 4 slat detail, wood feet.	<b>Red Oak</b>		
		FRY-TBL-4848-30-RO	48w 48d 30h	
		FRY-TBL-5454-30-RO	54w 54d 30h	
		FRY-TBL-6060-30-RO	60w 60d 30h	
		<b>Cherry</b>		
		FRY-TBL-4848-30-C	48w 48d 30h	
		FRY-TBL-5454-30-C	54w 54d 30h	
		FRY-TBL-6060-30-C	60w 60d 30h	
		<b>Maple</b>		
FRY-TBL-4848-30-M	48w 48d 30h			
FRY-TBL-5454-30-M	54w 54d 30h			
FRY-TBL-6060-30-M	60w 60d 30h			
	Square Study Table with edgeband, X-Base with 4 slat detail, wood feet.	<b>Red Oak</b>		
		FRY-TBX-4848-30-RO	48w 48d 30h	
		FRY-TBX-5454-30-RO	54w 54d 30h	
		FRY-TBX-6060-30-RO	60w 60d 30h	
		<b>Cherry</b>		
		FRY-TBX-4848-30-C	48w 48d 30h	
		FRY-TBX-5454-30-C	54w 54d 30h	
		FRY-TBX-6060-30-C	60w 60d 30h	
		<b>Maple</b>		
FRY-TBX-4848-30-M	48w 48d 30h			
FRY-TBX-5454-30-M	54w 54d 30h			
FRY-TBX-6060-30-M	60w 60d 30h			

Plastic laminate or Marmoleum® top standard, veneer top add 15%.  
Electrical options, wire management and accessories available, see pages 123-129.  
Custom modifications, youth and standing heights available upon request.

# AGATI

## FRYE COLLECTION

### STUDY TABLES

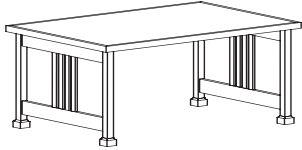

DESCRIPTION	ITEM NO	SIZE	STANDARD LIST	
Rectangular Study Table with edgeband, stretcher base with 4 slat detail, wood feet.	<b>Red Oak</b>			
	FRY-TBL-4836-30-RO	48w 36d 30h		
	FRY-TBL-6036-30-RO	60w 36d 30h		
	FRY-TBL-7236-30-RO	72w 36d 30h		
	FRY-TBL-4842-30-RO	48w 42d 30h		
	FRY-TBL-6042-30-RO	60w 42d 30h		
	FRY-TBL-7242-30-RO	72w 42d 30h		
	FRY-TBL-8442-30-RO	84w 42d 30h		
	FRY-TBL-9642-30-RO	96w 42d 30h		
	FRY-TBL-6048-30-RO	60w 48d 30h		
	FRY-TBL-7248-30-RO	72w 48d 30h		
	FRY-TBL-8448-30-RO	84w 48d 30h		
	FRY-TBL-9648-30-RO	96w 48d 30h		
	FRY-TBL-10848-30-RO	108w 48d 30h		
	FRY-TBL-8454-30-RO	84w 54d 30h		
	FRY-TBL-9654-30-RO	96w 54d 30h		
	FRY-TBL-10854-30-RO	108w 54d 30h		
	FRY-TBL-12054-30-RO	120w 54d 30h		
	FRY-TBL-8460-30-RO	84w 60d 30h		
	FRY-TBL-9660-30-RO	96w 60d 30h		
	FRY-TBL-10860-30-RO	108w 60d 30h		
	FRY-TBL-12060-30-RO	120w 60d 30h		
	<b>Cherry</b>			
	FRY-TBL-4836-30-C	48w 36d 30h		
	FRY-TBL-6036-30-C	60w 36d 30h		
	FRY-TBL-7236-30-C	72w 36d 30h		
	FRY-TBL-4842-30-C	48w 42d 30h		
	FRY-TBL-6042-30-C	60w 42d 30h		
	FRY-TBL-7242-30-C	72w 42d 30h		
	FRY-TBL-8442-30-C	84w 42d 30h		
	FRY-TBL-9642-30-C	96w 42d 30h		
	FRY-TBL-6048-30-C	60w 48d 30h		
FRY-TBL-7248-30-C	72w 48d 30h			
FRY-TBL-8448-30-C	84w 48d 30h			
FRY-TBL-9648-30-C	96w 48d 30h			
FRY-TBL-10848-30-C	108w 48d 30h			
FRY-TBL-8454-30-C	84w 54d 30h			
FRY-TBL-9654-30-C	96w 54d 30h			
FRY-TBL-10854-30-C	108w 54d 30h			
FRY-TBL-12054-30-C	120w 54d 30h			
FRY-TBL-8460-30-C	84w 60d 30h			
FRY-TBL-9660-30-C	96w 60d 30h			
FRY-TBL-10860-30-C	108w 60d 30h			
FRY-TBL-12060-30-C	120w 60d 30h			

Plastic laminate or Marmoleum® top standard, veneer top add 15%.  
 Electrical options, wire management and accessories available, see pages 123-129.  
 Custom modifications, youth and standing heights available upon request.

# AGATI

## FRYE COLLECTION

### STUDY TABLES

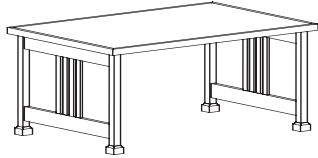

DESCRIPTION	ITEM NO	SIZE	STANDARD LIST
Rectangular Study Table with edgeband. Stretcher base with 4 slat detail, wood feet.	<b>Maple</b>		
	FRY-TBL-4836-30-M	48w 36d 30h	
	FRY-TBL-6036-30-M	60w 36d 30h	
	FRY-TBL-7236-30-M	72w 36d 30h	
	FRY-TBL-4842-30-M	48w 42d 30h	
	FRY-TBL-6042-30-M	60w 42d 30h	
	FRY-TBL-7242-30-M	72w 42d 30h	
	FRY-TBL-8442-30-M	84w 42d 30h	
	FRY-TBL-9642-30-M	96w 42d 30h	
	FRY-TBL-6048-30-M	60w 48d 30h	
	FRY-TBL-7248-30-M	72w 48d 30h	
	FRY-TBL-8448-30-M	84w 48d 30h	
	FRY-TBL-9648-30-M	96w 48d 30h	
	FRY-TBL-10848-30-M	108w 48d 30h	
	FRY-TBL-8454-30-M	84w 54d 30h	
	FRY-TBL-9654-30-M	96w 54d 30h	
	FRY-TBL-10854-30-M	108w 54d 30h	
	FRY-TBL-12054-30-M	120w 54d 30h	
	FRY-TBL-8460-30-M	84w 60 30h	
	FRY-TBL-9660-30-M	96w 60d 30h	
FRY-TBL-10860-30-M	108w 60d 30h		
FRY-TBL-12060-30-M	120w 60d 30h		

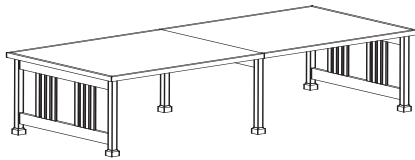

Rectangular Study Table with edgeband. Stretcher base with 4 slat detail, 6 legs, wood feet.	<b>Red Oak</b>		
	FRY-TBL-13254-30-RO	132w 54d 30h	
	FRY-TBL-14454-30-RO	144w 54d 30h	
	FRY-TBL-13260-30-RO	132w 60d 30h	
	FRY-TBL-14460-30-RO	144w 60d 30h	
	<b>Cherry</b>		
	FRY-TBL-13254-30-C	132w 54d 30h	
	FRY-TBL-14454-30-C	144w 54d 30h	
	FRY-TBL-13260-30-C	132w 60d 30h	
	FRY-TBL-14460-30-C	144w 60d 30h	
	<b>Maple</b>		
	FRY-TBL-13254-30-M	132w 54d 30h	
FRY-TBL-14454-30-M	144w 54d 30h		
FRY-TBL-13260-30-M	132w 60d 30h		
FRY-TBL-14460-30-M	144w 60d 30h		

Plastic laminate or Marmoleum® top standard, veneer top add 15%.  
 Electrical options, wire management and accessories available, see pages 123-129.  
 Custom modifications, youth and standing heights available upon request.

# AGATI

## FRYE COLLECTION

### TABLE CARRELS

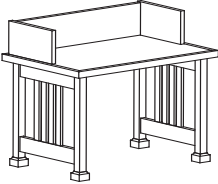
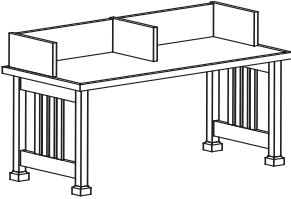
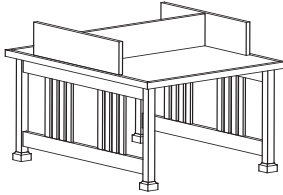
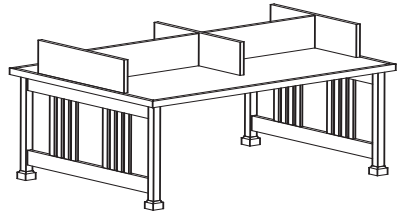
	DESCRIPTION	ITEM NO	SIZE	STANDARD LIST
	One Person Table Carrel with Marmoleum or plastic laminate top, wood edge, surround. Base with 4 slat detail, wood feet.	<b>Red Oak</b>		
		FRY-TBL-CRL-3632-39-RO	36w 32d 39h	
		FRY-TBL-CRL-4232-39-RO	42w 32d 39h	
		FRY-TBL-CRL-4832-39-RO	48w 32d 39h	
		FRY-TBL-CRL-5432-39-RO	54w 32d 39h	
		<b>Cherry</b>		
		FRY-TBL-CRL-3632-39-C	36w 32d 39h	
		FRY-TBL-CRL-4232-39-C	42w 32d 39h	
		FRY-TBL-CRL-4832-39-C	48w 32d 39h	
		FRY-TBL-CRL-5432-39-C	54w 32d 39h	
		<b>Maple</b>		
		FRY-TBL-CRL-3632-39-M	36w 32d 39h	
		FRY-TBL-CRL-4232-39-M	42w 32d 39h	
		FRY-TBL-CRL-4832-39-M	48w 32d 39h	
		FRY-TBL-CRL-5432-39-M	54w 32d 39h	
	Two Person, Single Faced Table Carrel Marmoleum or plastic laminate top, wood edge, surround. Base with 4 slat detail, wood feet.	<b>Red Oak</b>		
		FRY-TBL-CRL-7232-39-RO	72w 32d 39h	
		FRY-TBL-CRL-8432-39-RO	84w 32d 39h	
		FRY-TBL-CRL-9632-39-RO	96w 32d 39h	
		FRY-TBL-CRL-10832-39-RO	108w 32d 39h	
		<b>Cherry</b>		
		FRY-TBL-CRL-7232-39-C	72w 32d 39h	
		FRY-TBL-CRL-8432-39-C	84w 32d 39h	
		FRY-TBL-CRL-9632-39-C	96w 32d 39h	
		FRY-TBL-CRL-10832-39-C	108w 32d 39h	
		<b>Maple</b>		
		FRY-TBL-CRL-7232-39-M	72w 32d 39h	
		FRY-TBL-CRL-8432-39-M	84w 32d 39h	
		FRY-TBL-CRL-9632-39-M	96w 32d 39h	
		FRY-TBL-CRL-10832-39-M	108w 32d 39h	
	Two Person, Double Faced Table Carrel Marmoleum or plastic laminate top, wood edge, surround. Base with 4 slat detail, wood feet.	<b>Red Oak</b>		
		FRY-TBL-CRL-3660-39-RO	36w 60d 39h	
		FRY-TBL-CRL-4260-39-RO	42w 60d 39h	
		FRY-TBL-CRL-4860-39-RO	48w 60d 39h	
		FRY-TBL-CRL-5430-39-RO	54w 30d 39h	
		<b>Cherry</b>		
		FRY-TBL-CRL-3660-39-C	36w 60d 39h	
		FRY-TBL-CRL-4260-39-C	42w 60d 39h	
		FRY-TBL-CRL-4860-39-C	48w 60d 39h	
		FRY-TBL-CRL-5430-39-C	54w 30d 39h	
		<b>Maple</b>		
		FRY-TBL-CRL-3660-39-M	36w 60d 39h	
		FRY-TBL-CRL-4260-39-M	42w 60d 39h	
		FRY-TBL-CRL-4860-39-M	48w 60d 39h	
		FRY-TBL-CRL-5430-39-M	54w 30d 39h	
	Four Person, Double Faced Table Carrel Marmoleum or plastic laminate top, wood edge, surround. Base with 4 slat detail, wood feet.	<b>Red Oak</b>		
		FRY-TBL-CRL-7260-39-RO	72w 60d 39h	
		FRY-TBL-CRL-8460-39-RO	84w 60d 39h	
		FRY-TBL-CRL-9660-39-RO	96w 60d 39h	
		FRY-TBL-CRL-10860-39-RO	108w 60d 39h	
		<b>Cherry</b>		
		FRY-TBL-CRL-7260-39-C	72w 60d 39h	
		FRY-TBL-CRL-8460-39-C	84w 60d 39h	
		FRY-TBL-CRL-9660-39-C	96w 60d 39h	
		FRY-TBL-CRL-10860-39-C	108w 60d 39h	
		<b>Maple</b>		
		FRY-TBL-CRL-7260-39-M	72w 60d 39h	
		FRY-TBL-CRL-8460-39-M	84w 60d 39h	
		FRY-TBL-CRL-9660-39-M	96w 60d 39h	
		FRY-TBL-CRL-10860-39-M	108w 60d 39h	

Plastic laminate or Marmoleum® top standard, veneer top add 15%.  
 Electrical options, wire management and accessories available, see pages 123-129.  
 Custom modifications, youth and standing heights available upon request.

# AGATI

## FRYE COLLECTION

### STUDY CARRELS

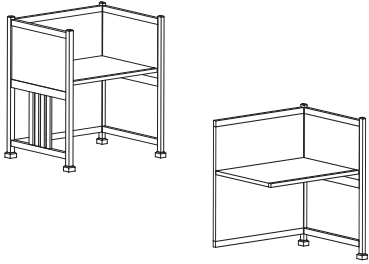
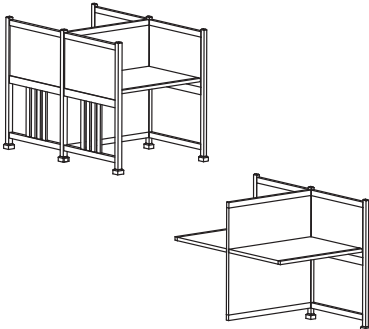
	DESCRIPTION	ITEM NO	SIZE	STANDARD LIST	
	Single Faced, One Person Study Carrel with plastic laminate top, 4 slat detail, wood feet.	<b>Red Oak</b>			
		Starter	FRY-CRL-STR-3630-48-RO	36w 30d 48h	
		Adder	FRY-CRL-ADR-3530-48-RO	35w 30d 48h	
		Starter	FRY-CRL-STR-4230-48-RO	42w 30d 48h	
		Adder	FRY-CRL-ADR-4130-48-RO	41w 30d 48h	
		Starter	FRY-CRL-STR-4830-48-RO	48w 30d 48h	
		Adder	FRY-CRL-ADR-4730-48-RO	47w 30d 48h	
		<b>Cherry</b>			
		Starter	FRY-CRL-STR-3630-48-C	36w 30d 48h	
		Adder	FRY-CRL-ADR-3530-48-C	35w 30d 48h	
		Starter	FRY-CRL-STR-4230-48-C	42w 30d 48h	
		Adder	FRY-CRL-ADR-4130-48-C	41w 30d 48h	
		Starter	FRY-CRL-STR-4830-48-C	48w 30d 48h	
		Adder	FRY-CRL-ADR-4730-48-C	47w 30d 48h	
<b>Maple</b>					
Starter	FRY-CRL-STR-3630-48-M	36w 30d 48h			
Adder	FRY-CRL-ADR-3530-48-M	35w 30d 48h			
Starter	FRY-CRL-STR-4230-48-M	42w 30d 48h			
Adder	FRY-CRL-ADR-4130-48-M	41w 30d 48h			
Starter	FRY-CRL-STR-4830-48-M	48w 30d 48h			
Adder	FRY-CRL-ADR-4730-48-M	47w 30d 48h			
	Double Faced, Two Person Study Carrel with plastic laminate top, 4 slat detail, wood feet.	<b>Red Oak</b>			
		Starter	FRY-CRL-STR-3660-48-RO	36w 60d 48h	
		Adder	FRY-CRL-ADR-3560-48-RO	35w 60d 48h	
		Starter	FRY-CRL-STR-4260-48-RO	42w 60d 48h	
		Adder	FRY-CRL-ADR-4160-48-RO	41w 60d 48h	
		Starter	FRY-CRL-STR-4860-48-RO	48w 60d 48h	
		Adder	FRY-CRL-ADR-4760-48-RO	47w 60d 48h	
		<b>Cherry</b>			
		Starter	FRY-CRL-STR-3660-48-C	36w 60d 48h	
		Adder	FRY-CRL-ADR-3560-48-C	35w 60d 48h	
		Starter	FRY-CRL-STR-4260-48-C	42w 60d 48h	
		Adder	FRY-CRL-ADR-4160-48-C	41w 60d 48h	
		Starter	FRY-CRL-STR-4860-48-C	48w 60d 48h	
		Adder	FRY-CRL-ADR-4760-48-C	47w 60d 48h	
<b>Maple</b>					
Starter	FRY-CRL-STR-3660-48-M	36w 60d 48h			
Adder	FRY-CRL-ADR-3560-48-M	35w 60d 48h			
Starter	FRY-CRL-STR-4260-48-M	42w 60d 48h			
Adder	FRY-CRL-ADR-4160-48-M	41w 60d 48h			
Starter	FRY-CRL-STR-4860-48-M	48w 60d 48h			
Adder	FRY-CRL-ADR-4760-48-M	47w 60d 48h			

Plastic laminate or Marmoleum® top standard, veneer top add 15%.  
 Electrical options, wire management and accessories available, see pages 123-129.  
 Custom modifications, youth and standing heights available upon request.

# AGATI

## FRYE COLLECTION

### STUDY CARRELS

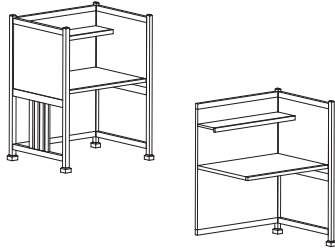

Single Faced, One Person Study Carrel with plastic laminate top, 4 slat detail, wood feet. Features overhead shelf.

#### Red Oak

ITEM NO	SIZE
Starter FRY-CRL-STR-3630-54-RO	36w 30d 54h
Adder FRY-CRL-ADR-3530-54-RO	35w 30d 54h
Starter FRY-CRL-STR-4230-54-RO	42w 30d 54h
Adder FRY-CRL-ADR-4130-54-RO	41w 30d 54h
Starter FRY-CRL-STR-4830-54-RO	48w 30d 54h
Adder FRY-CRL-ADR-4730-54-RO	47w 30d 54h

#### Cherry

Starter FRY-CRL-STR-3630-54-C	36w 30d 54h
Adder FRY-CRL-ADR-3530-54-C	35w 30d 54h
Starter FRY-CRL-STR-4230-54-C	42w 30d 54h
Adder FRY-CRL-ADR-4130-54-C	41w 30d 54h
Starter FRY-CRL-STR-4830-54-C	48w 30d 54h
Adder FRY-CRL-ADR-4730-54-C	47w 30d 54h

#### Maple

Starter FRY-CRL-STR-3630-54-M	36w 30d 54h
Adder FRY-CRL-ADR-3530-54-M	35w 30d 54h
Starter FRY-CRL-STR-4230-54-M	42w 30d 54h
Adder FRY-CRL-ADR-4130-54-M	41w 30d 54h
Starter FRY-CRL-STR-4830-54-M	48w 30d 54h
Adder FRY-CRL-ADR-4730-54-M	47w 30d 54h

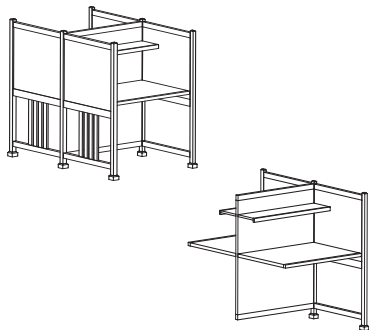

Double Faced, Two Person Study Carrel with plastic laminate top, 4 slat detail, wood feet. Features overhead shelf.

#### Red Oak

Starter FRY-CRL-STR-3660-54-RO	36w 60d 54h
Adder FRY-CRL-ADR-3560-54-RO	35w 60d 54h
Starter FRY-CRL-STR-4260-54-RO	42w 60d 54h
Adder FRY-CRL-ADR-4160-54-RO	41w 60d 54h
Starter FRY-CRL-STR-4860-54-RO	48w 60d 54h
Adder FRY-CRL-ADR-4760-54-RO	47w 60d 54h

#### Cherry

Starter FRY-CRL-STR-3660-54-C	36w 60d 54h
Adder FRY-CRL-ADR-3560-54-C	35w 60d 54h
Starter FRY-CRL-STR-4260-54-C	42w 60d 54h
Adder FRY-CRL-ADR-4160-54-C	41w 60d 54h
Starter FRY-CRL-STR-4860-54-C	48w 60d 54h
Adder FRY-CRL-ADR-4760-54-C	47w 60d 54h

#### Maple

Starter FRY-CRL-STR-3660-54-C	36w 60d 54h
Adder FRY-CRL-ADR-3560-54-C	35w 60d 54h
Starter FRY-CRL-STR-4260-54-C	42w 60d 54h
Adder FRY-CRL-ADR-4160-54-C	41w 60d 54h
Starter FRY-CRL-STR-4860-54-C	48w 60d 54h
Adder FRY-CRL-ADR-4760-54-C	47w 60d 54h

Plastic laminate or Marmoleum® top standard, veneer top add 15%.

Electrical options, wire management and accessories available, see pages 123-129.

Custom modifications, youth and standing heights available upon request.

# AGATI

# FRYE COLLECTION

## ACCESSORIES

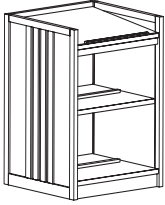
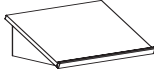
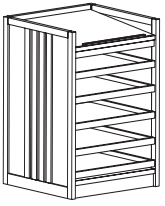
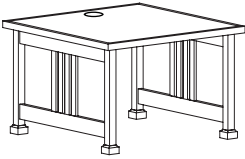
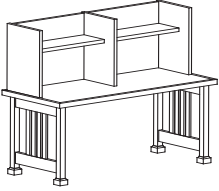
	DESCRIPTION	ITEM NO	SIZE	STANDARD LIST
	Dictionary Stand with 4 slat detail.	<b>Red Oak</b> FRY-DIC-3029-45-RO	30w 29d 45h	
		<b>Cherry</b> FRY-DIC-3029-45-C		
		<b>Maple</b> FRY-DIC-3029-45-M		
	Dictionary Stand, Table Top.	FRY-RVDIC-2114-8-RO	21w 14d 8h	
		FRY-RVDIC-2114-8-C	21w 14d 8h	
		FRY-RVDIC-2114-8-M	21w 14d 8h	
	Atlas Stand with 4 slat detail.	<b>Red Oak</b> FRY-ATL-3029-45-RO	30w 29d 45h	
		<b>Cherry</b> FRY-ATL-3029-45-C		
		<b>Maple</b> FRY-ATL-3029-45-M		
	Printer Stand/Computer Table with 4 slat detail, wood feet. Includes wire management grommet.	<b>Red Oak</b> FRY-TBL-PRT-3030-30-RO	30w 30d 30h	
		<b>Cherry</b> FRY-TBL-PRT-3030-30-C		
		<b>Maple</b> FRY-TBL-PRT-3030-30-M		
	Single Faced Index Table with Marmoleum or plastic laminate top wood edge, surround. 4 slat detail with wood feet.	<b>Red Oak</b> FRY-TBL-IND-7232-5430-RO	72w 32d 54h	
		<b>Cherry</b> FRY-TBL-IND-7232-5430-C	72w 32d 54h	
		<b>Maple</b> FRY-TBL-IND-7232-5430-M	72w 32d 54h	
	Double Faced Index Table	<b>Red Oak</b> FRY-TBL-IND-7260-5430-RO	72w 60d 54h	
		<b>Cherry</b> FRY-TBL-IND-7260-5430-C	72w 60d 54h	
		<b>Maple</b> FRY-TBL-IND-7260-5430-M	72w 60d 54h	

Plastic laminate or Marmoleum® top standard, veneer top add 15%.  
Electrical options, wire management and accessories available, see pages 123-129.  
Custom modifications, youth and standing heights available upon request.

# AGATI

# FRYE COLLECTION

## END PANELS

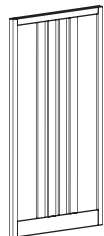

DESCRIPTION	ITEM NO	SIZE	STANDARD LIST
Single Faced End Panel Up to 66" high (h) Up to 90" high (h)	<b>Red Oak</b> FRY-EP-SF-1266-RO FRY-EP-SF-1290-RO	12w 66h 1.25th 12w 90h 1.25th	
Double Faced End Panel Up to 66" high (h) Up to 90" high (h)	FRY-EP-DF-2466-RO FRY-EP-DF-2490-RO	24w 66h 1.25th 24w 90h 1.25th	
Single Faced End Panel Up to 66" high (h) Up to 90" high (h)	<b>Cherry</b> FRY-EP-SF-1266-C FRY-EP-SF-1290-C	12w 66h 1.25th 12w 90h 1.25th	
Double Faced End Panel Up to 66" high (h) Up to 90" high (h)	FRY-EP-DF-2466-C FRY-EP-DF-2490-C	24w 66h 1.25th 24w 90h 1.25th	
Single Faced End Panel Up to 66" high (h) Up to 90" high (h)	<b>Maple</b> FRY-EP-SF-1266-M FRY-EP-SF-1290-M	12w 66h 1.25th 12w 90h 1.25th	
Double Faced End Panel Up to 66" high (h) Up to 90" high (h)	FRY-EP-DF-2466-M FRY-EP-DF-2490-M	24w 66h 1.25th 24w 90h 1.25th	

## TOP CAPS



DESCRIPTION	ITEM NO	SIZE	STANDARD LIST
Single Faced Width Top Cap Priced per foot length (l)	<b>Red Oak</b> FRY-TC-SF-12xx-RO	12w xxl 1.25th	
Double Faced Width Top Cap Priced per foot length (l)	FRY-TC-DF-24xx-RO	24w xxl 1.25th	
File Cabinet Width Top Cap Priced per foot length (l)	FRY-TC-FC-36xx-RO	36w xxl 1.25th	
Single Faced Width Top Cap Priced per foot length (l)	<b>Cherry</b> FRY-TC-SF-12xx-C	12w xxl 1.25th	
Double Faced Width Top Cap Priced per foot length (l)	FRY-TC-DF-24xx-C	24w xxl 1.25th	
File Cabinet Width Top Cap Priced per foot length (l)	FRY-TC-FC-36xx-C	36w xxl 1.25th	
Single Faced Width Top Cap Priced per foot length (l)	<b>Maple</b> FRY-TC-SF-12xx-M	12w xxl 1.25th	
Double Faced Width Top Cap Priced per foot length (l)	FRY-TC-DF-24xx-M	24w xxl 1.25th	
File Cabinet Width Top Cap Priced per foot length (l)	FRY-TC-FC-36xx-M	36w xxl 1.25th	
Filler Strip Moulding Small-Finished filler strip	FRY-FLLR-3-3-96	8 ft. lengths	
Filler Strip Moulding Large-Finished filler strip	FRY-FLLR-6-3-96	8 ft. lengths	

Plastic laminate or Marmoleum® top standard, veneer top add 15%.  
Custom modifications available upon request.

# AGATI

## FRYE COLLECTION

### SERVICE AREAS

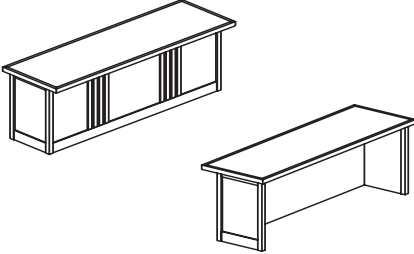
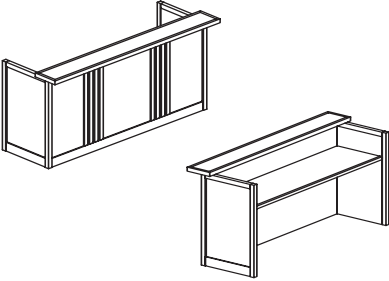
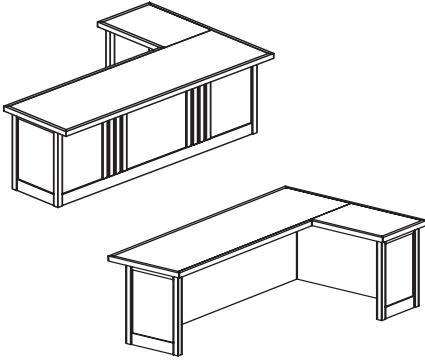
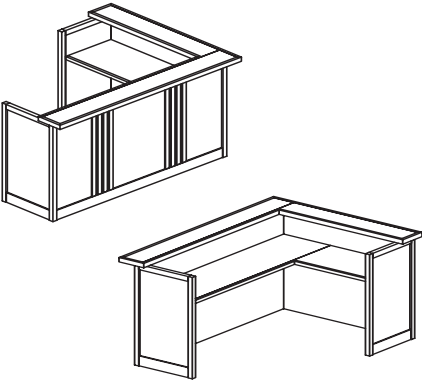
SERVICE AREAS	DESCRIPTION	ITEM NO	SIZE	STANDARD LIST
	Straight Desk with modesty panel, wood edgeband and panel sides with 4 slat detail.	<b>Red Oak</b> FRY-DSK-9630-30-RO  <b>Cherry</b> FRY-DSK-9630-30-C  <b>Maple</b> FRY-DSK-9630-30-M	96w 30d 30h  96w 30d 30h  96w 30d 30h	
	Straight Desk with transaction surface, modesty panel, wood edgeband and panel sides with 4 slat detail.	<b>Red Oak</b> FRY-DSK-TRN-9633-4230-RO  <b>Cherry</b> FRY-DSK-TRN-9633-4230-C  <b>Maple</b> FRY-DSK-TRN-9633-4230-M	96w 33d 42h  96w 33d 42h  96w 33d 42h	
	Desk with return and modesty panel, wood edgeband and panel sides with 4 slat detail.	<b>Red Oak</b> FRY-DSK-RHR-9672-30-RO FRY-DSK-LHR-9672-30-RO  <b>Cherry</b> FRY-DSK-LHR-9672-30-C FRY-DSK-LHR-9672-30-C  <b>Maple</b> FRY-DSK-LHR-9672-30-M FRY-DSK-LHR-9672-30-M	96w 72d 30h 96w 72d 30h  96w 72d 30h 96w 72d 30h  96w 72d 30h 96w 72d 30h	
	Desk with return, transaction surface, modesty panel, wood edgeband and panel sides with 4 slat detail.	<b>Red Oak</b> FRY-DSK-RHR-TRN-9672-4230-RO FRY-DSK-LHR-TRN-9672-4230-RO  <b>Cherry</b> FRY-DSK-LHR-TRN-9672-4230-C FRY-DSK-LHR-TRN-9672-4230-C  <b>Maple</b> FRY-DSK-LHR-TRN-9672-4230-M FRY-DSK-LHR-TRN-9672-4230-M	96w 72d 42h 96w 72d 42h  96w 72d 42h 96w 72d 42h  96w 72d 442 96w 72d 42h	

Plastic laminate or Marmoleum® top standard, veneer top add 15%.  
 Electrical options, wire management and accessories available, see pages 123-129.  
 Custom modifications, youth and standing heights available upon request.