

AGATI

Welcome to AGATI

AGATI Furniture is known for its innovative designs, durable construction and exceptional customer service. Throughout the years, the name AGATI has become synonymous with the words classic, quality and value. Offering a commitment that extends well beyond its competitors, AGATI has earned its reputation as a premier manufacturer and resource to architects and designers across markets.

Furniture styles range from classic, standard collections to contemporary designs and custom modifications. Each year brings more product offerings and a wider range of styles without compromising the integrity of the product. In the 1980's AGATI launched its library division. Word of mouth praise from librarians, architects and designers across the country helped AGATI build its name and solidify its foothold in the market. AGATI attributes its strong client base and repeat customers to solid relationships, a willingness to listen and individualized attention.

At the foundation of AGATI is its Design and Engineering department. Offering years of expertise, an in-house Design and Engineering team takes the project from drawing board to delivery. Furniture is made specifically for each project in order to meet the client's needs. AGATI understands the value of being a resource to both the client and the designer and takes every effort to ensure the greatest long-term return on investment.

AGATI collections are original designs and are constructed to endure constant heavy use. Wood side and arm chairs are assembled with mortise and tenon joints that are secured with hardwood metal pins, making the strongest joint possible. Chairs feature one-piece, steam bent, solid lumber back posts for superior stability and strength. Chair backs are engineered with lumbar support shaped into the back splats or slats, as well as designed for patron comfort. Table bases are constructed with end aprons and leg stretchers, and are mounted to the bottom face of the table tops with steel plates secured with mechanical fasteners. This structure provides a foundation for a solid, long lasting work surface. The time, effort, and care expended in the manufacturing of these products ensures many years of safe use.

In a world where resources are at a premium, AGATI takes its role seriously by staying current with green processes and technological advances. As clients increasingly turn to the internet for instant information retrieval, AGATI is able to provide faster access to resources through www.agati.com. Keeping the website fresh and timely allows AGATI to scale back on the amount of printed materials distributed.

The information age also translates into AGATI's furniture as power and data wire management issues are addressed before undertaking a project's furnishing designs. And while facilities are equipped with the most modern equipment and technology, traditional spindle carving and profile shapers still remain AGATI specialties. It is this contrast that demonstrates the foundation of AGATI – an ability to stay true to its roots in traditional design, while keeping in step with an ever-changing world primed for AGATI's inventive perspective on furniture design.

Ultimately, Agati furniture is built to stand the test of time. We believe in extraordinary architecture and remarkable furniture, and we look forward to enhancing your environment for years to come. Thank you for your interest in AGATI.



Agati-Inc



Agati Inc.



AgatiFurniture



Agati-Furniture



AgatiFurniture



Agati Furniture



Warranty

AGATI, Inc. manufactures its products to the highest quality standards. Therefore, AGATI products are warranted against all defects in materials and workmanship for a period of ten years from date of delivery. This warranty does not extend to COM, COL or any other customer supplied materials. During the warranty period, AGATI will, at its discretion, repair or replace defective merchandise free of charge.

The AGATI warranty is against defects in workmanship that would lead to the following: veneer lifting or peeling, glue joint failure, and wood joints pulling apart. AGATI handcrafts and finishes its products using the finest hardwoods and traditional hand finishing techniques. AGATI uses finishing techniques that are intended to highlight the inherent beauty of the wood used in its products. Depending upon the figure of the wood used, certain areas may absorb the stain differently than others. Wood is a natural product and will naturally have slight flaws and imperfections, which enhance the overall beauty. Customers should be aware that all finishes will mellow with age. Since wood is a natural material, some expansion and contraction is to be expected. The foregoing is not to be considered a defect in the materials or manufacturing process used and is not covered under warranty.

The AGATI warranty covers the lifting of any plastic laminate from the substrate but can only underwrite the laminate manufacturer's guarantee against scratching and chipping.

This warranty does not extend to damage resulting from shipping, accident, alteration, misuse, tampering, negligence, abuse, acts of God, or ordinary wear and tear. This warranty is given expressly and in lieu of all other warranties, expressed or implied, of merchantability and fitness for particular purpose and constitutes the only warranty made by AGATI. No warranty is made with respect to non-standard materials selected by and used at the request of the customer. No merchandise may be returned to AGATI without AGATI's written approval.

In addition to a ten year warranty, AGATI stands by a philosophy that buying AGATI is buying the future. AGATI constructs all of its products to enjoy a lifetime of use. However, furniture inherently ages and AGATI understands needs may change throughout a product's life cycle. Therefore, AGATI will continue to address service, design, and engineering issues and extend maintenance to all products for the duration of their use.

Etta

Guest Armchair





Crafted for Comfort

The Etta Guest Armchair expands the Etta collection with a fully upholstered design suited for working, studying, or dining. With mix-and-match materials and a replaceable seat, it offers designers a balance of form, function, and durability. Available with either a solid wood four-leg base or a polished aluminum swivel X-base, Etta brings comfort to any setting.

Designed to Perform

The seat was designed with cleanability in mind. It can be fully replaced if damaged and features a push-through around all edges for easy maintenance. This allows crumbs and debris to fall to the floor when pushed between the seat and back.

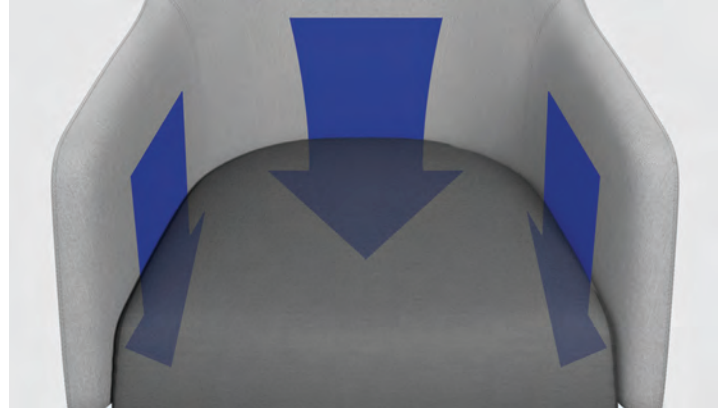

PRODUCT LINE



Etta Guest Armchair Wood Base
• 27" W x 28"D x 36"H



Etta Guest Armchair X-Base
• 27" W x 28"D x 36"H
• Return swivel

SPECIFICATIONS

Fabric Options

Standard Fabric Finishes

Base Finishes

X Base Standard - Polished Aluminum (return swivel)
Wood Leg Standard - Natural Maple

Etta

High Back Lounge





Crafted for Comfort

With an impressive silhouette, subtle recline, and easy-clean design, Etta High Back Lounge offers guests a comfortable, stylish place to relax - perfect for busy airports and welcoming libraries. Available with either a solid wood four-leg base or a polished aluminum swivel X-base, Etta brings comfort to any setting.

Designed to Perform

The seat was designed with cleanability in mind. It can be fully replaced if damaged and features a push-through around all edges for easy maintenance. This allows crumbs and debris to fall to the floor when pushed between the seat and back.

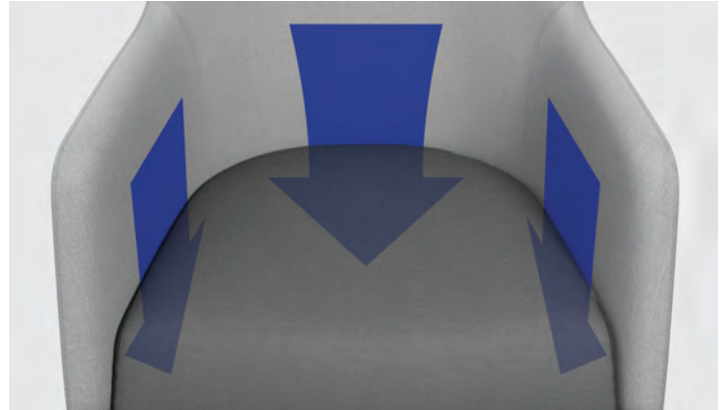

PRODUCT LINE



Etta High Back Lounge Wood Base
• 27" W x 29"D x 39"H



Etta High Back Lounge X-Base
• 27" W x 29"D x 39"H
• Return swivel

SPECIFICATIONS

Fabric Options

Standard Fabric Finishes

Base Finishes

X Base Standard - Polished Aluminum (return swivel)

Wood Leg Standard - Natural Maple

DEPARTURES

Airport Seating



Departures Seating

A high-density airport seating solution that reimagines the gate experience. AGATI's latest terminal seating system is designed to optimize passenger comfort and terminal flow. Available in linear runs with either straight or angled seating configurations. Durable yet refined, Departures features stone or laminate surface tables with integrated power, sleek metal legs, and enhanced seating with a gently curved backrest.



Personal Tables

- Constructed with high-end stone or laminate tops
- Integrated power: AC, USB-A, USB-C, one per seat

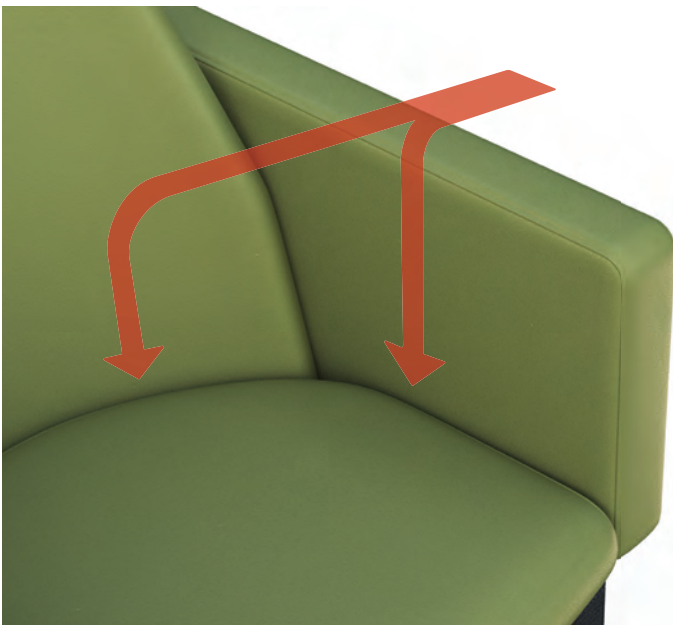

Crumb Pass through

- Easy to clean by pushing a hand through our anti-crumb pass troughs

Footprint Comparison

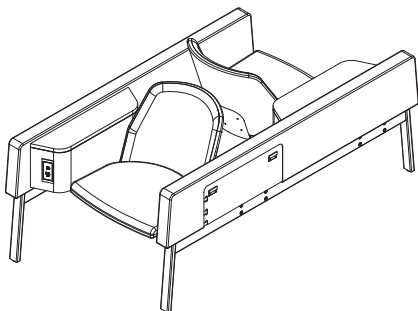
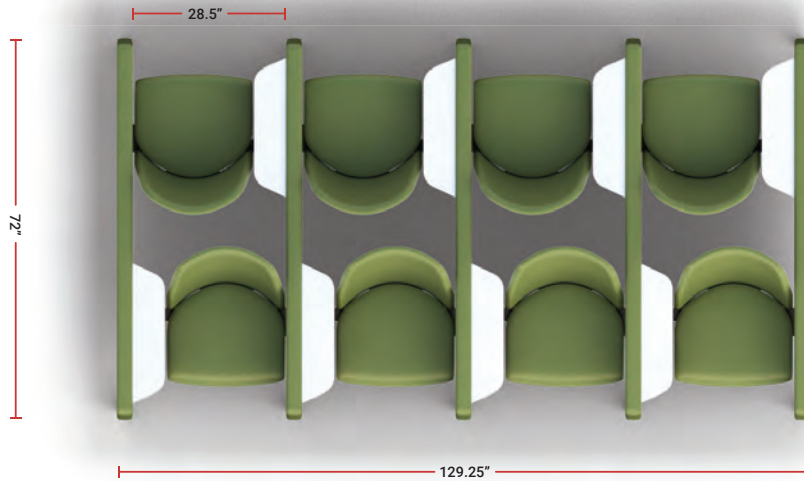
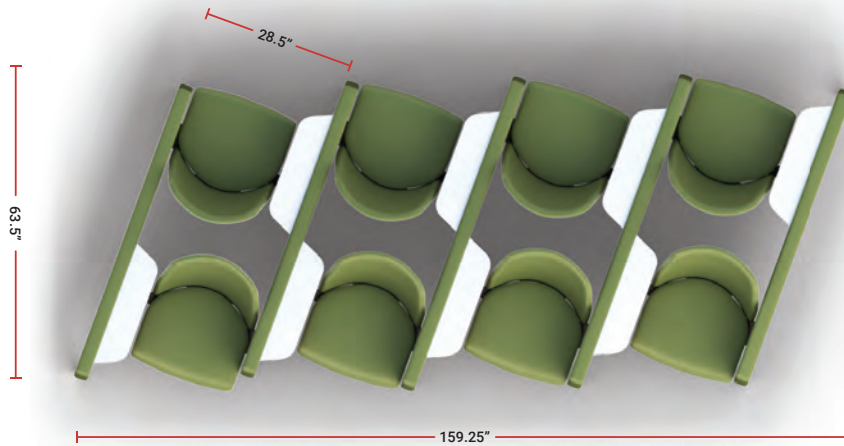

Starter

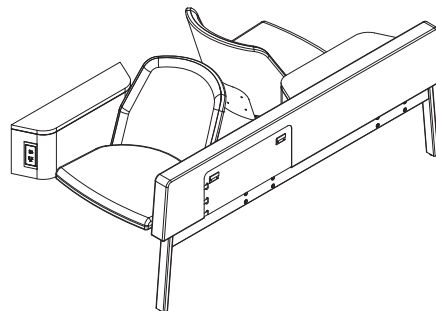

Adder

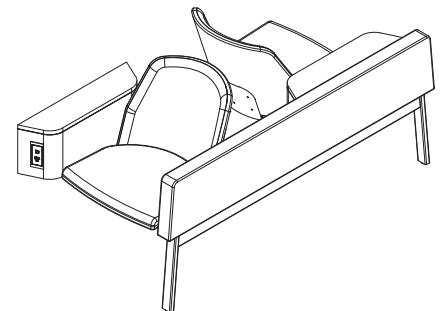



End

- Each configuration contains one starter and one end section
- Configuration lengths can be customized by adding or removing adder pieces

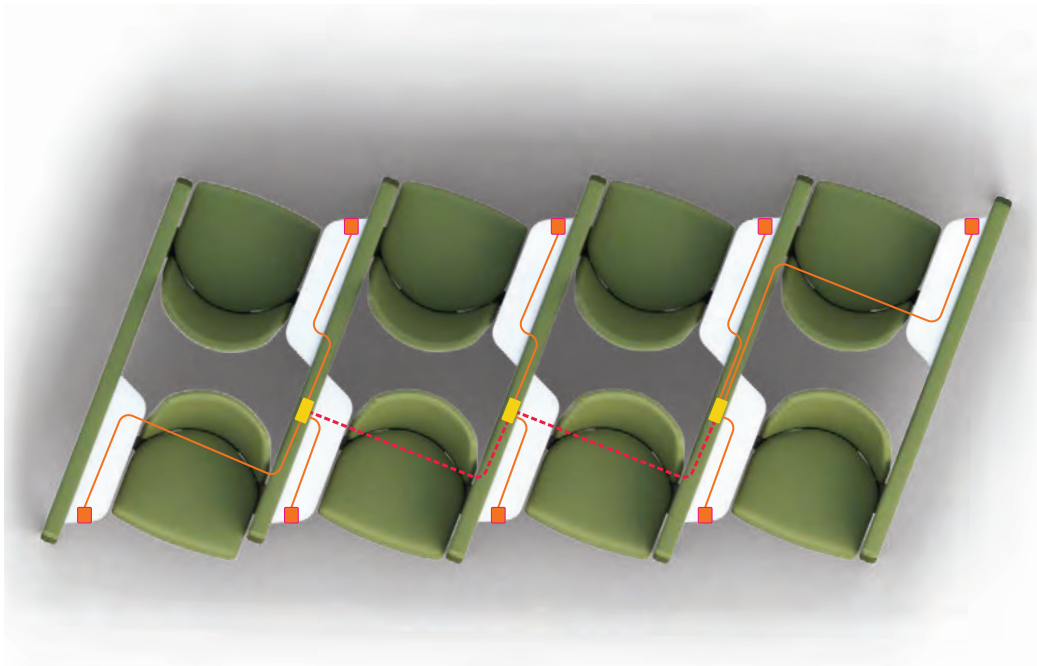
Electrical Routing



-  - 2 Port Power Receptacle
-  - 4 Port Connector
-  - Jumper Cable

PRODUCT LINE

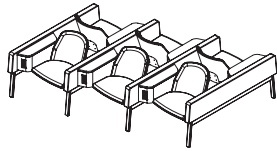

Left Angled Configurations

- 4 Person – 93" W x 63.5"D x 33"H
- 6 Person – 125.5" W x 63.5"D x 33"H
- 8 Person – 159.5" W x 63.5"D x 33"H
- 10 Person – 193" W x 63.5"D x 33"H

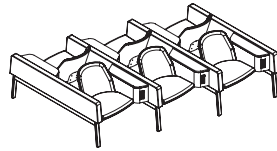

Right Angled Configurations

- 4 Person – 93" W x 63.5"D x 33"H
- 6 Person – 125.5" W x 63.5"D x 33"H
- 8 Person – 159.5" W x 63.5"D x 33"H
- 10 Person – 193" W x 63.5"D x 33"H

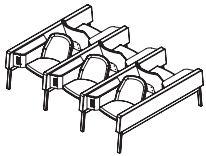

Streight Configurations

- 4 Person – 66.25" W x 72"D x 33"H
- 6 Person – 97.75" W x 72"D x 33"H
- 8 Person – 129.25" W x 72"D x 33"H
- 10 Person – 161" W x 72"D x 33"H

SPECIFICATIONS

Fabric Options

Standard Fabric Finishes

Table Options

Tops — Stone
 Body — Plastic Laminate
 Power — AC, USB-A, USB-C

Base Powdercoats

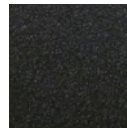

Black Fine
Texture

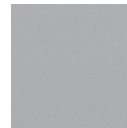

Metallic Silver

AGATI
FURNITURE

Call 312.829.1977 or visit us at agati.com

COVE
Carrel





The Cove Carrel

The Cove Carrel is a contemporary solution that advances today's environments, while fulfilling the age-old need for private workspace within a public space. The Cove Carrel offers these innovative enhancements:

- Flexible for different environments: Use as a stand-alone carrel, or create a range of adaptable configurations based on your available space.
- Addresses a range of sound distractions: Leading edge acoustic panels dampen noise for users and for entire space.
- Aligns with social responsibility goals: Eco-friendly nature of recycled materials in panels promotes a more sustainable planet.
- Updated power integration, durability and maintenance remedies.



Focus Haven

The Cove Carrel is designed to provide users with a sense of security and privacy so they can focus. When used as a stand-alone carrel, the wall panel extends 2" beyond the work surface. Sitting at the carrel, one feels this extension wrap around them more than traditional carrels. When multiple Cove Carrels are linked together in a serpentine configuration, this wall extension lengthens even further, providing additional privacy.



Wire Management

Seamless power integration makes the Cove Carrel functional for both the user and the space. In-Surface Power can flow down to the floor on both sides through the exterior leg, depending on your power location. USB-A + C plus 2 outlets are standard on tabletop.

Durability

This carrel was designed for exceptional durability, featuring metal edges at all wear points and sturdy metal legs to ensure longevity and robustness. Additionally, its interior has durable acoustical paneling that allows for easy cleaning, enhancing practicality and maintenance efficiency.

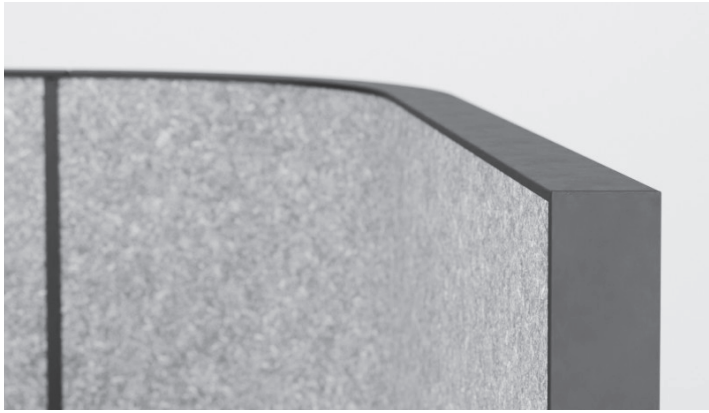

PRODUCT LINE



- 48" Cove Carrel**
- 48" W x 30"D x 48"H
 - 26" Deep Worksurface

SPECIFICATIONS

Worksurface & Panel

Standard Laminate Options

Base & Edge

Powdercoated Metal

Acoustical Paneling



White



Grey

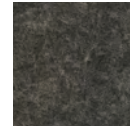

Slate

Powdercoats



Black Fine Texture

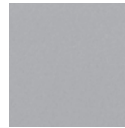

Metallic Silver



Call 312.829.1977 or visit us at agati.com

ADAPT2

Tables



Adapt2 Tables

Adapt2 Table Collection offers a wide range of shapes, sizes and materials to provide multiple options for library and university designs. Support various and changing community needs with the Adapt2 Table Collection.



PRODUCT LINE

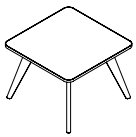

- Square Table**
- 42" W x 42"D x 30"H
 - 48" W x 48"D x 30"H



- Soft Square Table**
- 42" W x 42"D x 30"H
 - 48" W x 48"D x 30"H



- Boat Table**
- Length - 60", 72", 84", 96"
 - Depth - 36", 42", 48"
 - Height - 30"

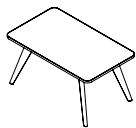

- Rectangle Table**
- Length - 60", 72", 84", 96"
 - Depth - 36", 42", 48"
 - Height - 30"



- Circle Table**
- 42" W x 42"D x 30"H
 - 48" W x 48"D x 30"H

SPECIFICATIONS

Worksurface

Standard Laminate Options

Electrical

On-Surface - 4 Port (2 Power & 2 USB-A +C)

Base Finishes

Wood Standard - Natural Maple

Metal Standard - Black Fine Texture, White, Metallic Silver

Powdercoats

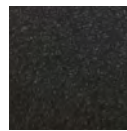

Black Fine
Texture

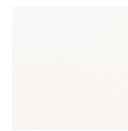

White

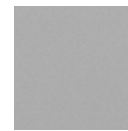

Metallic Silver

AGATI
FURNITURE

Call 312.829.1977 or visit us at Agati.com

ADAPT2

Workstations



ADAPT2 Your Space

Adapt2 provides the flexibility to reconfigure your space, at any time, without any hassle. Choose from the Trapezoid, Rectangle and Arrow Wrap tabletop shapes. Arrange tables in various configurations for group work, or add acoustic panels for individual privacy. Easily move Adapt2 from stand-alone workstations to various groupings as frequently as you like -our tested durability and engineered mobility ensures they remain strong for years of public use.



Flexible Power

Each Adapt2 Workstation includes a strategic wire management solution. On-surface power gives users easy access to connect, while the power strip underneath the worksurface offers a convenient extension. Two cable management spools neatly wrap any excess cord length. Legs are engineered with tracks to encase and precisely route cord down to floor.

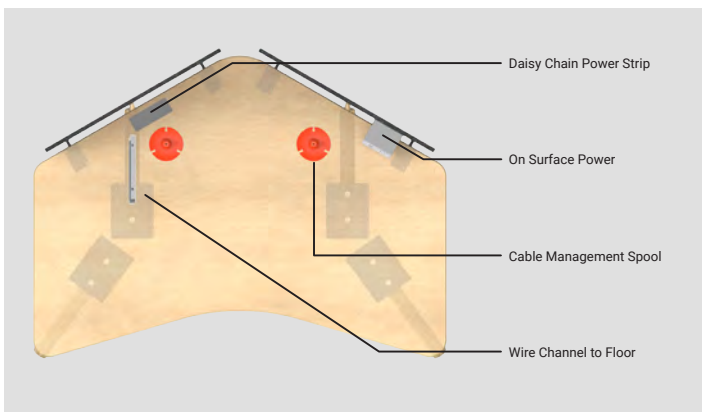



Legs

Select from metal or solid maple legs. With a focus on extreme durability, Adapt2 legs are engineered for frequent movement. Wheels on back two legs facilitate easy rolling when front two legs are lifted. Adapt2 is deliberately designed to stay steadfast through weight distribution when set in place.

PRODUCT LINE



Adapt Arrow Wrap Workstation
• 48" W x 35"D x 30"H



Adapt Arrow Wrap Workstation
• 48" W x 35"D x 30"H
• Two Acoustical Panels



Adapt Rectangle Workstation
• 48" W x 30"D x 30"H



Adapt Rectangle Workstation
• 48" W x 30"D x 30"H
• Acoustical Panel



Adapt Trapezoid Workstation
• 48" W x 30"D x 30"H



Adapt Trapezoid Workstation
• 48" W x 30"D x 30"H
• Acoustical Panel

SPECIFICATIONS

Worksurface

Standard Laminate Options

Electrical

On-Surface (1 Power & 2 Port USB-A +C)

Base Finishes

Wood Standard - Natural Maple

Metal Standard - Black Fine Texture, White, Metallic Silver

Powdercoats

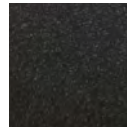

Black Fine
Texture

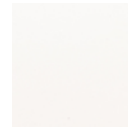

White



Metallic Silver

Acoustical Paneling

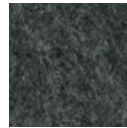

Slate



Tar

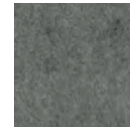

Fossil

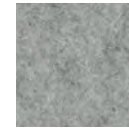

Greige



Linen

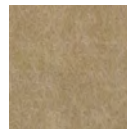

Ecrú



Ochre



Grass



Cobalt



Sky



Mandarin

AGATI
FURNITURE

Call 312.829.1977 or visit us at agati.com

CUBIT
Display Shelving



Introducing Cubit

Cubit is a compact display, browsing, and storage unit built for shared spaces like libraries, classrooms, and universities. With a clean aesthetic, durable materials, and thoughtfully designed bin options, Cubit makes books and materials easy to see, reach, and engage with, encouraging interaction without adding visual clutter.



Smart, Functional Design

Cubit is available with two bin options: divider and open. Divider bins organize smaller collections with a panel to prop up books for better visibility. Open bins support bulk browsing. Both can be flipped to create a plinth-style display surface. Each bin lifts out completely to reveal hidden storage below, ideal for backup items or less frequently accessed materials.

PRODUCT LINE

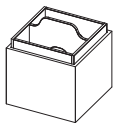

Cubit 24" High with Divider Box
• 24"W x 24"D x 24"H

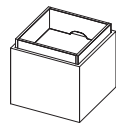

Cubit 24" High with Open Box
• 24"W x 24"D x 24"H

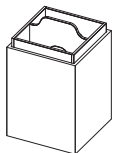

Cubit 36" High with Divider Box
• 24"W x 24"D x 36"H

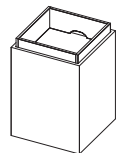

Cubit 36" High with Open Box
• 24"W x 24"D x 36"H

SPECIFICATIONS

Interior Box Finishes

Standard Plastic Laminates

Cubit Metal Finishes

Powdercoated

Powdercoats

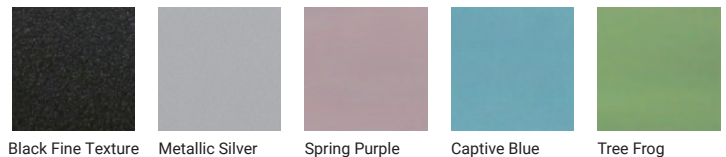

BLOCKS

Display Shelving



Architectural Displays

Blocks introduces a fresh perspective on display shelving with its tiered structure, offering an architectural aesthetic that beautifully showcases books stored in various configurations. Whether you're placing books in spine-out or a displaying a new collection, Blocks provides ample shelves to suit your needs.



PRODUCT LINE

SPECIFICATIONS



Blocks 72" High
• 24"W x 24"D x 72"H

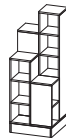

Blocks 66" High
• 24"W x 24"D x 66"H



Blocks 54" High
• 24"W x 24"D x 54"H

Plastic Laminate Options

Standard Plastic Laminates

Base Options

Hidden Non-Locking Casters
Levelers

BRICKS

Display Shelving

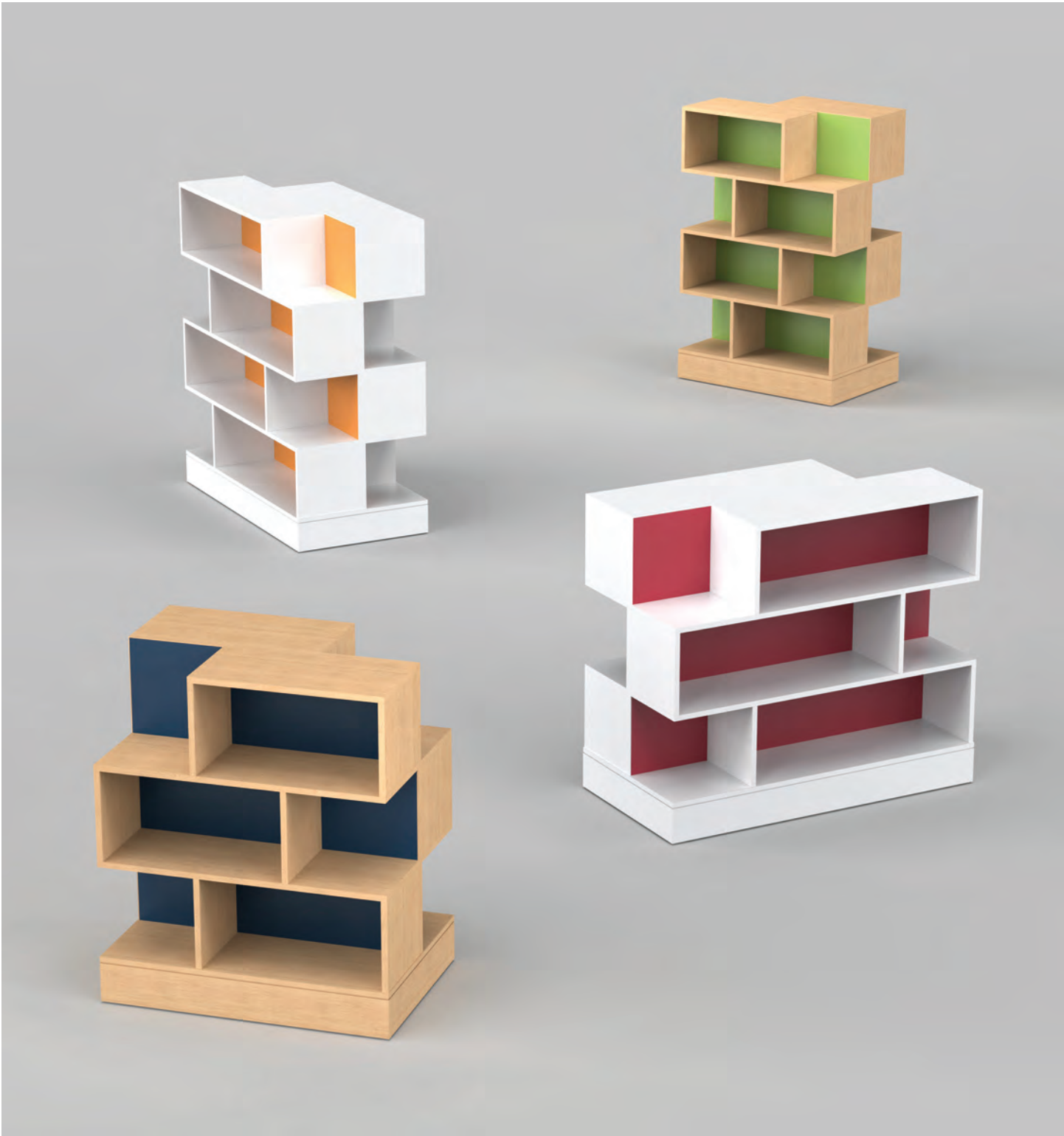

Architectural Displays

Bricks presents a novel approach to display shelving, characterized by its architectural aesthetic of vertically stacked bricks. This design provides ample space for showcasing books, complemented by side nooks ideal for displaying items or new additions to your collection. And the offer for two tone adds flare to the books being displayed inside, along with adding color to your library.



PRODUCT LINE

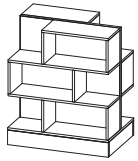

Bricks 36"
• 36" W x 24"D x 42"H

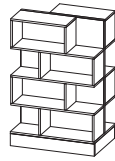

Bricks 36"
• 36" W x 24"D x 54"H

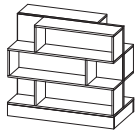

Bricks 48"
• 48" W x 24"D x 42"H

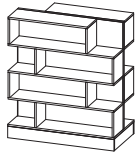

Bricks 48"
• 48" W x 24"D x 54"H

SPECIFICATIONS

Plastic Laminate Options

Standard Plastic Laminates

Base Options

Hidden Non-Locking Casters
Levelers

ETTA



At last, the Etta Collection from AGATI Furniture. AGATI designs from a higher perspective, one which utilizes key consumer insights in engineering to increase public furniture standards. The Etta collection does this by incorporating a light Modernist aesthetic into traditional furniture.

Power options are available for tables and casters available for chairs, bringing mobility and power to modern environments.

AGATI
FURNITURE

www.agati.com

ETTA



*Available with power



Seating

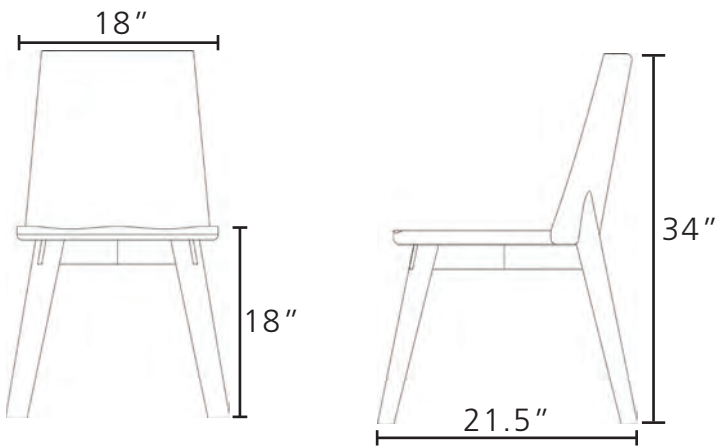

Table

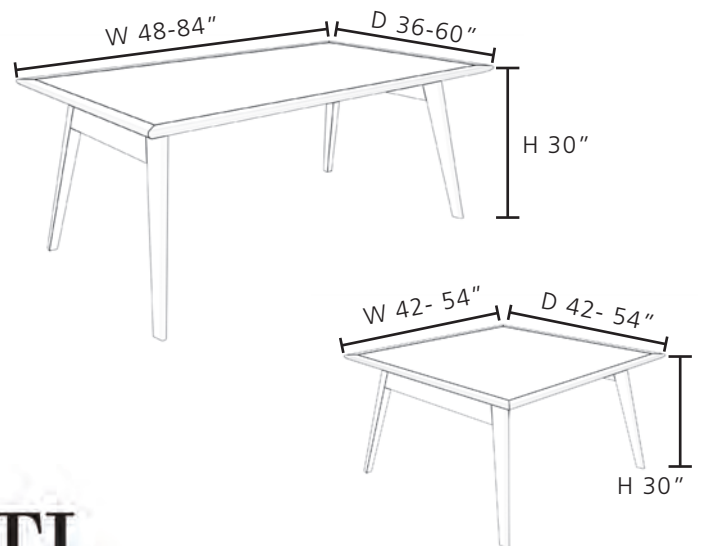

POD Collection

Study Carrel



POD Single, POD Duo, POD Carrel

POD Single

KEY FEATURES

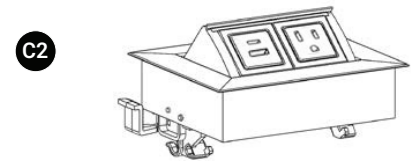
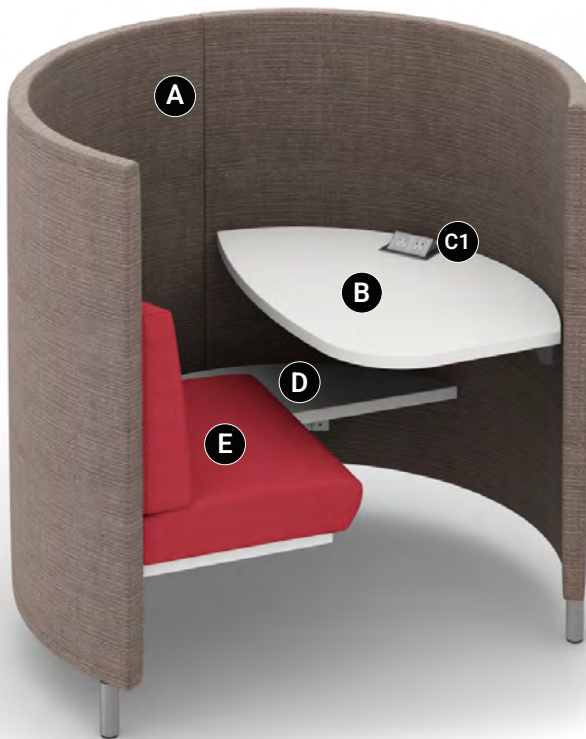

HARD WIRED



PLUG SET

- A Upholstered Surrounds**
Soft, upholstered panels create a comfortable, semi-private work-space while helping reduce ambient noise.
- B Plastic Laminate Work Surface**
Durable, easy-to-clean laminate surface designed to withstand heavy daily use in high-traffic environments.
- C Power Accessibility**
Integrated Surface Mount Power Pop Up keep devices charged and within reach, supporting productivity without interruption.

- D Side Shelf**
Convenient side shelf provides additional space for books, bags, or personal items, keeping the main work area clear.
- E Fixed Bench with Cushioned Seat and Back**
Built-in bench seating offers a sturdy, space-efficient solution with a supportive and comfortable feel.
- F Configurations**
Available in a range of layouts to support individual study and flexible space planning.

PRODUCT LINE



POD Single
• 52" Dia x 49"H x 19"Sh

SPECIFICATIONS

Fabric Options

COM Fabric
*Fabrics must be tested for approval

Base Finishes

Metal Leg Base with Clear Anodized Aluminum Finish

Add-ons

Power Options: Surface Mount Power Pop Up
*1 Power Outlet 1 USB A+C Outlets

KEY FEATURES

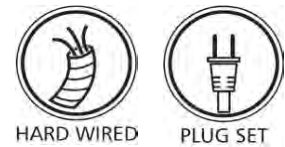
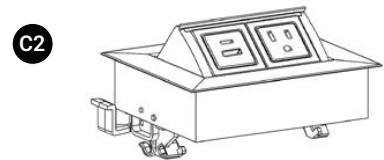
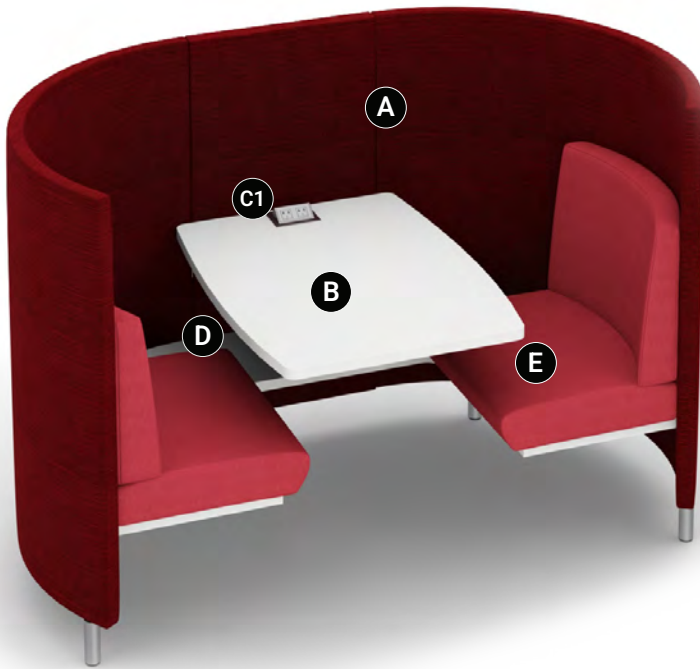

- A Upholstered Surrounds**
Soft, upholstered panels create a comfortable, semi-private work-space while helping reduce ambient noise.
- B Plastic Laminate Work Surface**
Durable, easy-to-clean laminate surface designed to withstand heavy daily use in high-traffic environments.
- C Power Accessibility**
Integrated Surface Mount Power Pop Up keep devices charged and within reach, supporting productivity without interruption.

- D Side Shelf**
Convenient side shelf provides additional space for books, bags, or personal items, keeping the main work area clear.
- E Fixed Bench with Cushioned Seat and Back**
Built-in bench seating offers a sturdy, space-efficient solution with a supportive and comfortable feel.
- F Configurations**
Available in a range of layouts to support individual study, collaboration, and flexible space planning.

PRODUCT LINE



POD Duo
• 76" W x 41"D x 49"H x 19"Sh

SPECIFICATIONS

Fabric Options

COM Fabric
*Fabrics must be tested for approval

Base Finishes

Metal Leg Base with Clear Anodized Aluminum Finish

Add-ons

Power Options: Surface Mount Power Pop Up
*1 Power Outlet 1 USB A+C Outlets

KEY FEATURES

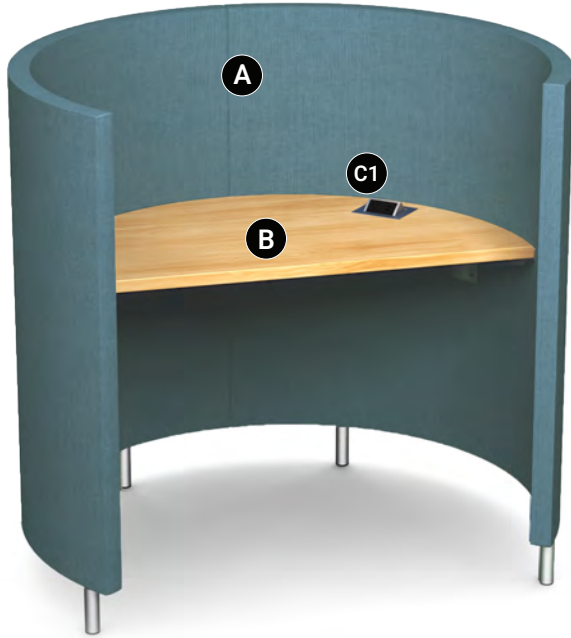

D



C2

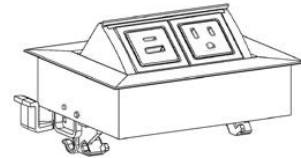

HARD WIRED



PLUG SET

A Upholstered Surrounds

Soft, upholstered panels create a comfortable, semi-private work-space while helping reduce ambient noise.

B Plastic Laminate Work Surface

Durable, easy-to-clean laminate surface designed to withstand heavy daily use in high-traffic environments.

C Power Accessibility

Integrated Surface Mount Power Pop Up keep devices charged and within reach, supporting productivity without interruption.

D Configurations

Available in a range of layouts to support individual study and flexible space planning.

PRODUCT LINE



POD Carrel
• 52" Dia x 49"H x 29" Sh

SPECIFICATIONS

Fabric Options

COM Fabric
*Fabrics must be tested for approval

Base Finishes

Metal Leg Base with Clear Anodized Aluminum Finish

Add-ons

Power Options: Surface Mount Power Pop Up
*1 Power Outlet 1 USB A+C Outlets

NOOK



Nook expands the Hampton banquette family by offering the same classic-yet-modern style in a private workspace. Available in several different configurations, Nook's flexibility can be adapted for just about any area where focused study space is a must.

The hallmark material quality and seating ergonomics found in the Hampton line carries over into the Nook's design; it can stand alone or create a consistent aesthetic when surrounded by its "siblings" from the Hampton family.



AGATI
FURNITURE

NOOK

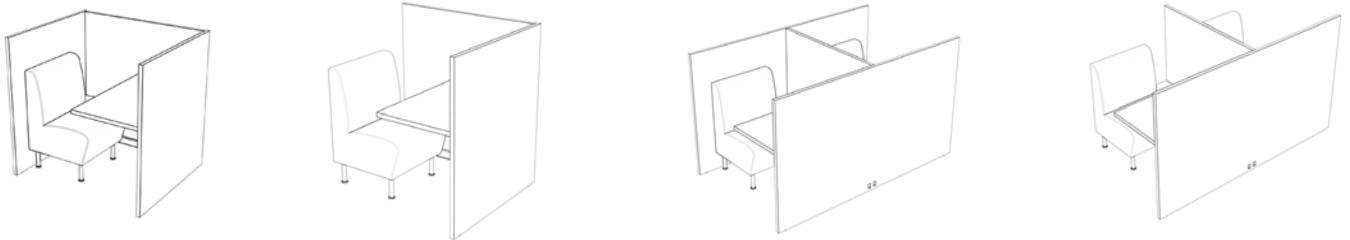

Specifications

- Wood veneer or plastic laminate surround
- Upholstered Hampton seating
- Standard plastic laminate work surface and side shelf with PVC edgeband
- Clear anodized aluminum legs
- Power option includes 1 power & 1 dual port USB pop up at work surface, plug set or 4trak (hardwired).

**Fabrics must be tested for approval*

Dimensions

Starter width: 49"
Adder width: 48"

Single faced depth: 42"

Double faced depth: 84"

Overall height: 48"

Seat height: 19"

AGATI
FURNITURE

NOOK DUO



NOOK DUO



Specifications

Surrounds: Veneer or Plastic Laminate

Upholstered Hampton Seating

Standard plastic laminate work surface and side shelf with PVC edgeband

Clear anodized aluminum legs

Power options: plug set or 4trak (hardwired). Both include 2 power & 1 dual port USB pop up.

**Fabrics must be tested for approval*

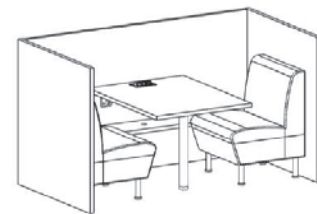

AGATI
FURNITURE

www.agati.com

POD Jr



AGATI
FURNITURE

REDUCE DISTRACTIONS

The enclosed panels on the POD Jr ensure immediate visual stimulation is minimized, providing a calm area to focus and enabling learning to take place while dampening sound.

SENSE OF SECURITY

The enclosed back also provides a sense of space and security, which can be comforting and supportive for all children.

Cleanable acoustical paneling & acrylic



Ample workspace

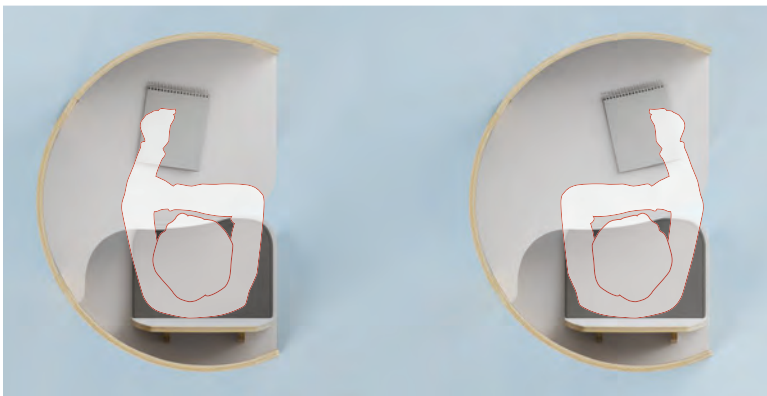

Designed for left and right handed users

Reovable and replaceable seat cushion



AGATI
FURNITURE

Pod Jr

Modeled after the revolutionary original design of the POD Study Carrel for libraries and public spaces, our team is eager to introduce the POD Jr, a specialized adaptation of the POD design for young learners at home.

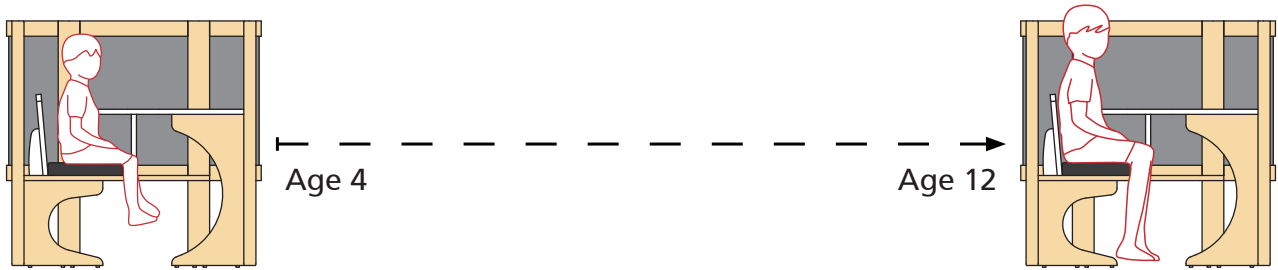

POD JR - FELT

37.5"W x 27"D x 36"H
16"Seat Height



POD JR - ACRYLIC

37.5"W x 27"D x 36"H
16"Seat Height



**POD JR - FELT
- No Seat**

37.5"W x 27"D x 36"H
14"Seat Height



**POD JR - ACRYLIC
- No Seat**

37.5"W x 27"D x 36"H
14"Seat Height



POWER BAR/TABLE COLLECTION

Available options:

- POWER TABLE
- POWER BAR
- SKINNY POWER BAR
- POWER BAR WITH ADA EXTENSION



Help your patrons recharge.

AGATI's Power Bar/Table Collection upgrades public spaces by providing functionality for users in a clean, minimal design. Combine pieces from the collection for a cohesive aesthetic.

Expert craftsmanship, tested engineering, and durable materials ensure the Power Bar/Table Collection withstands the test of time.

Designed and made in the USA.



AGATI
FURNITURE

POWER BAR



As one of the first to engineer and build Power Bars for the busiest of airports, the AGATI Power Bar is a tested favorite.

A charging station with power outlets that line the edge of the work surface, the Power Bar is as functional as it is stylish.

Wire management is contained behind the side panels, so all you see is a modern and inviting space.



AGATI
FURNITURE

www.agati.com

POWER BAR

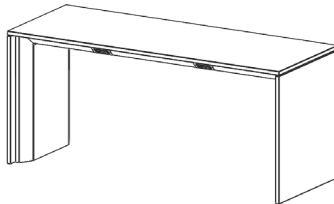
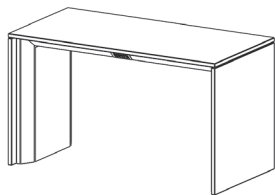

Specifications

- Top & Side Panels: Plastic Laminate or Stone
- Base: Stainless Steel or Powder Coat
- 72" Wide Includes 1 Electrical unit per side
96" Wide Includes 2 Electrical units per side
120" Wide Includes 3 Electrical units per side
- Each electrical unit includes 2 Power and 1 USB A+C port

Dimensions

Width: 72", 96", or 120"
Depth: 36", or 30"
Height: 42"

*Custom options available upon request.

SKINNY POWER BAR



Maximize usable space with the Skinny Power Bar along windows, walls, or in the center of a room.

Pair with stools, or use as a walk up charging counter.

Outlets along the apron rail leave the work surface free of clutter.

Choose mounted screen and modesty panel option to create privacy in an open space.



SKINNY POWER BAR



Specifications

- With or without mounted screen and modesty panel (all one piece)
- Top & Side Panels: Plastic Laminate or Ston
Base: Stainless Steel or Powder Coat
- 72" Wide Includes 1 Electrical unit per side
96" Wide Includes 2 Electrical units per side
120" Wide Includes 3 Electrical units per side
- Each electrical unit includes 2 Power and 1 USB A+C port
- Single-sided power is available upon request.
Single-sided power is standard when modesty panel is specified

Dimensions

Width: 72", 96", or 120"
Depth: 18", or 24"
Height: 42"

Note: Skinny Bar needs to be bolted down at both ends

POWER TABLE



AGATI's Power Table is striking as a stand alone piece, with it's strong, streamlined design.

Collaboration tables give users community space to recharge and work together or alone.

Pair with Power Bars to give users alternate height options while maintaining a cohesive aesthetic.

Outlets on the work surface leave space underneath clear for users when seated at table height.

Choose from a wide array of durable materials to compliment your design.



AGATI
FURNITURE

www.agati.com

POWER TABLE

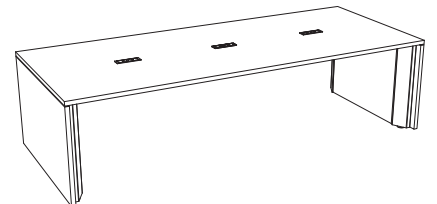
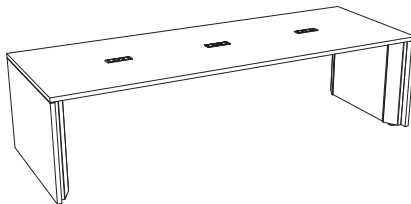
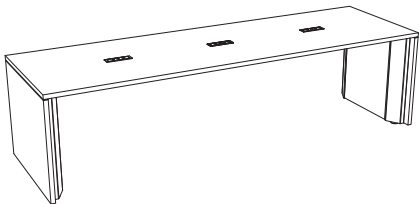
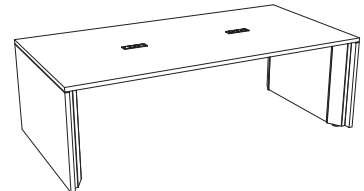
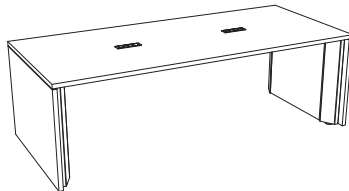
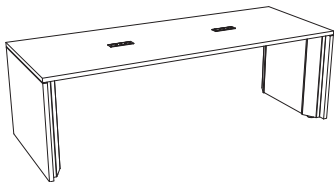
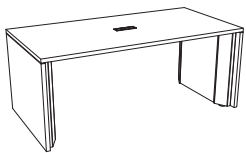

Specifications

- Top & Side Panels: Plastic Laminate or Stone
- Base: Stainless Steel or Powder Coat
- 72" Wide Includes 1 Electrical unit on tabletop
96" Wide Includes 2 Electrical units on tabletop
120" Wide Includes 3 Electrical units on tabletop
- Each electrical unit includes 2 Power and 1 USB A+C port

Dimensions

Width: 72", 96", or 120"
Depth: 36", 42", or 48"
Height: 30"

- Can meet ADA Standards

AGATI
FURNITURE

POWER BAR - ADA EXTENSION



ADA compliant, this extension option changes the Power Bar to a two-height bar, making it more universally accessible.

Electrical unit is added to side panel of the standard height Power Bar.

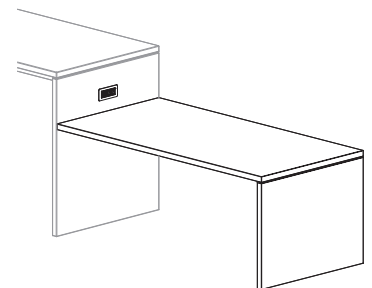
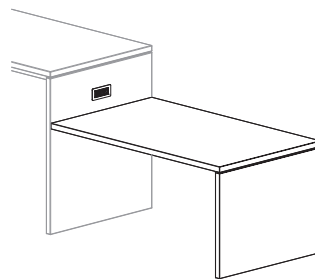
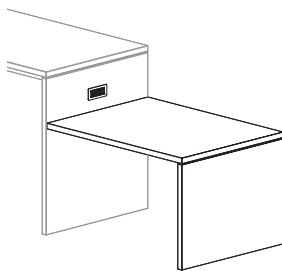
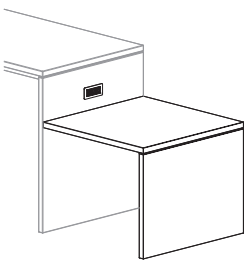

Specifications

- Top & Side Panels: Plastic Laminate or Stone
- Base: Stainless Steel or Powder Coat
- Each electrical unit includes 2 Power and 1 USB A+C port

Dimensions

Width: 36", 48", 60" or 72"
Depth: 30" or 36"
Height: 30"

AGATI
FURNITURE

ORB
Lounge



Orb Lounge Chair

The Orb Lounge Chair wraps around guests like a baseball glove. Organic, circular shapes lend creativity to your floor plan in airport terminals, universities, libraries, or any public space. The wide, cushioned seat pan supports users for longer wait times. Orb has just the right amount of lumbar support to bolster users, too. Choose from three different leg base options.

The Orb was designed to simplify long-term maintenance. Easily remove the back and seat sections for ease of care, increasing the longevity of your furniture. Extremely durable, this lounge chair with a metal base is built to endure long public use.



PRODUCT LINE



- X - Base Orb Lounge**
- 18SH 30"W x 30"D x 30H
 - Return Swivel



- Disc Base Orb Lounge**
- 18SH 30"W x 30"D x 30H
 - Free Swivel



- 4 Leg Orb Lounge**
- 18SH 30"W x 30"D x 30H

SPECIFICATIONS

Fabric Options

Standard Fabric Finishes (vinyls need to be tested)

Base Finishes

X Base Standard - Polished Aluminum

Disc Base Standard - Metallic Silver Powdercoat

4 Leg Standard - Black Fine Texture, White, Metallic Silver

Powdercoats Options

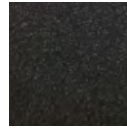

Black Fine
Texture

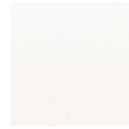

White



Metallic Silver

AGATI
FURNITURE

Call 312.829.1977 or visit us at agati.com

VERA



AGATI
FURNITURE



PASS THROUGH FOR EASY CLEANABILITY



WIRE MANAGEMENT CHANNELS ATTACH TO FRAME

CONNECTING TABLES

THIS SEMI-MODULAR LOUNGE COLLECTION PROVIDES A VARIETY OF SEATING CONFIGURATIONS AND THE ABILITY TO MAKE LONG RUNS OF SINGLE SEATS, DOUBLE SEATS, AND BENCHES

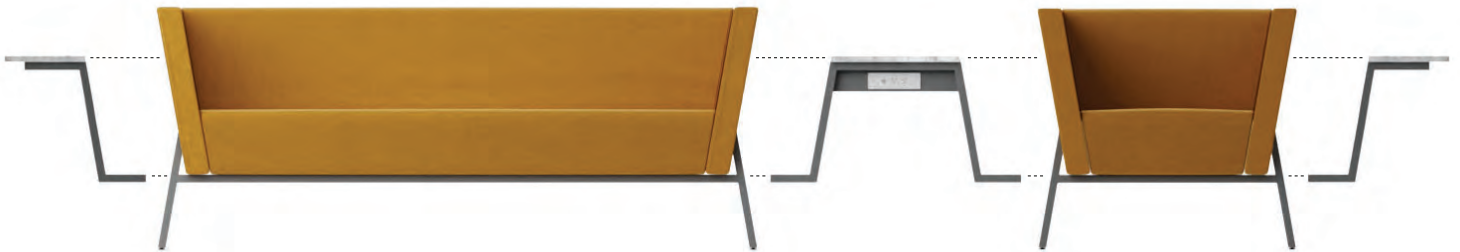

ELECTRICAL

POWER IS DISTRIBUTED THROUGH WIRE MANAGEMENT CHANNELS AND ALLOW FOR DROP TO FLOOR AT YOUR FLOORBOX LOCATION





The Vera Lounge Collection

The Vera Collection offers a contemporary, angular design, along with the comfort of wrap-around arms. This semi-modular collection provides a variety a seating configurations, seamless power integration, easy cleanability, and easy maintenance.

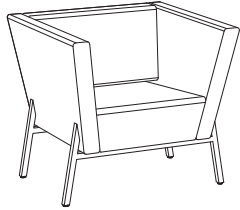

LOUNGE CHAIR

32"W x 30"D x 30"H
18"Seat Height

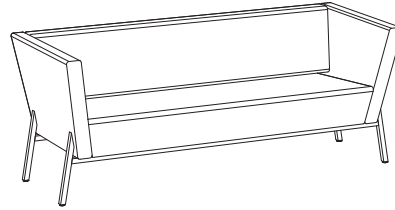

SETTEE

74"W x 30"D x 30"H
18"Seat Height

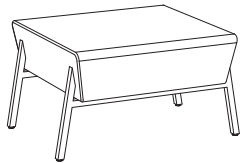

OTTOMAN

32"W x 30"D x 18"H
18"Seat Height

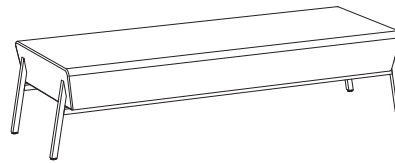

BENCH

74"W x 30"D x 18"H
18"Seat Height

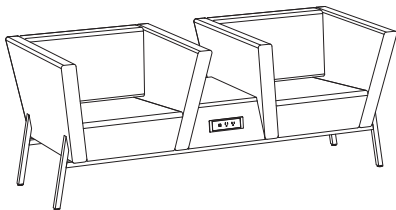

DOUBLE LOUNGE CHAIR WITH POWER TABLE

74"W x 30"D x 30"H
18"Seat Height

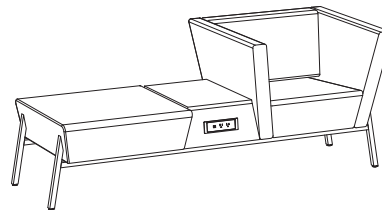

LOUNGE CHAIR WITH OTTOMAN WITH POWER TABLE RF

74"W x 30"D x 30"H
18"Seat Height

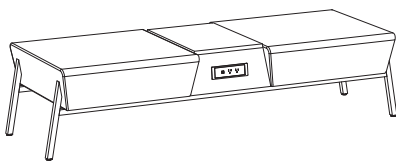

DOUBLE OTTOMAN WITH POWER TABLE

74"W x 30"D x 18"H
18"Seat Height

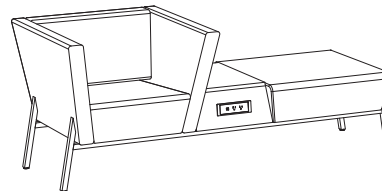

LOUNGE CHAIR WITH OTTOMAN WITH POWER TABLE LF

74"W x 30"D x 30"H
18"Seat Height

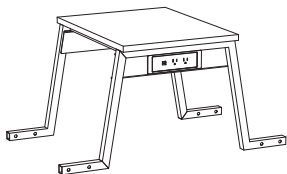

CONNECTION TABLE

16"W x 20 1/4"D
24" or 18" Above Finished Floor

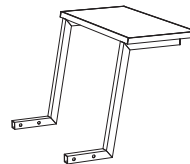

SIDE TABLE

10"W x 20 1/4"D
24" or 18" Above Finished Floor



FRAMEWORK

We often see libraries face a consistent problem: They simply don't have enough private study rooms or meeting space for their students and patrons.

And the issue makes sense. Many libraries can't devote much space to private rooms because they have to address such a diverse set of needs. Group work. Individual study. Children's space. Physical space for books. Meeting space. Areas for teens. Resources for seniors. Computer stations. Classrooms. And the list goes on.

In some academic libraries, the issue gets even more complicated. Many of these libraries were built years ago, and the growth of the university has outpaced the expansion of the library, and resources like study rooms never go unoccupied.

And if you take into account the global health crisis, space issues in libraries get even more complex. Now, we have to make our limited space stretch even further, be intentional about adjusting the flow of our facility, and figure out creative ways to promote social distancing among patrons.

This is where FrameWork, our newest addition to the Agati lineup, comes in with a simple and innovative approach to solving space issues.



FrameWork Curve



FrameWork Straight



FRAMEWORK



Metal Finish

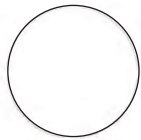

White



Metallic Silver



Argento 305



Argento 308

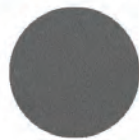

Mist Grey



Black Fine Texture

Felt Colors



Marble



Grey



Pepper



Charcoal



Oat



Stone



Earth Brown



Teal



Navy



Pear



Red



Pumpkin

Think of the possibilities



FRAMEWORK

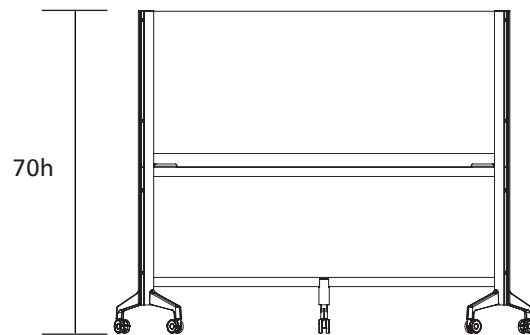
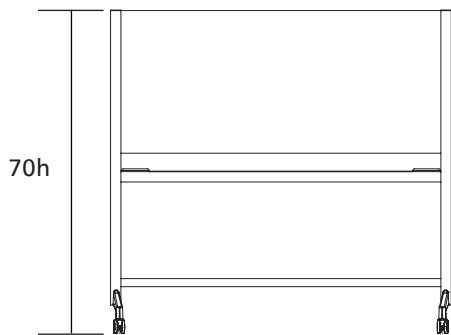
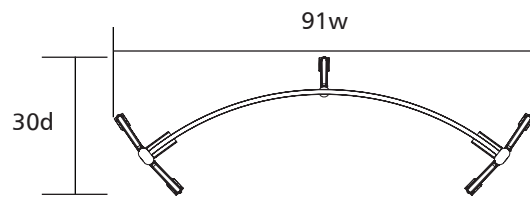
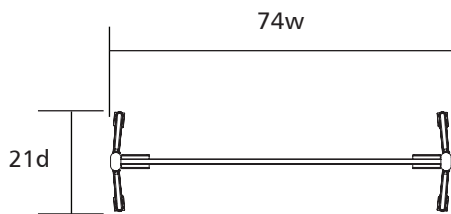
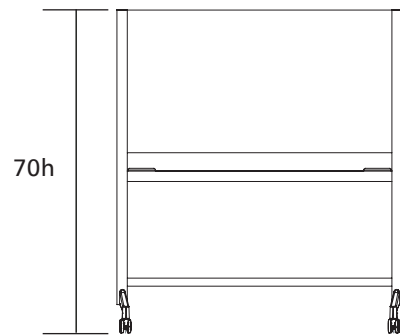
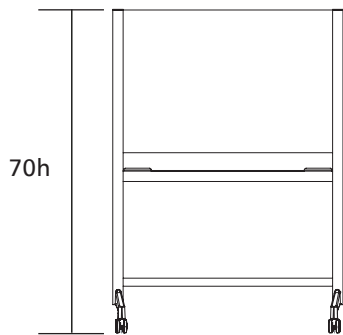
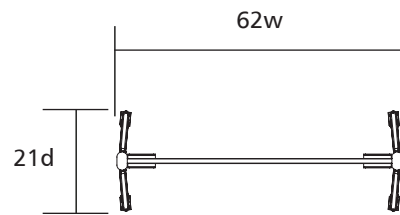
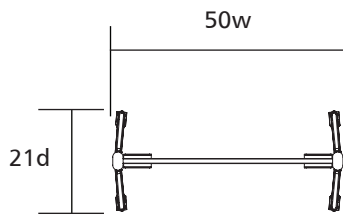

MANIFEST





Six person workstation with 3Form dividers.

Built upon the same institutional standards that have become an AGATI signature, the Manifest features a durable, cantilevered table top. Behind its modern design, Manifest is solidly constructed to withstand the rigors of everyday use allowing Manifest to effortlessly transition between markets.



Three person pod with 3Form dividers.



Manifest 6 with 3Form dividers.



Six person zig-zag workstation with 3Form dividers.

MANIFEST Desking System

Smart, simple, workspace solutions.

The Manifest Desking System is AGATI's newest and most contemporary desking system built upon the idea of affordable collaboration and configurability.

Designed in response to a need for a more collaborative work solution, Manifest is lighter in scale and design making it easy to configure to groups of all sizes and work needs. Optional returns or mobile tables allow for more seamless communication, integrated into standard configurations that include a straight bench, 120-degree pod or the aesthetically pleasing "zigzag" station.

Easy to set up and install, the Manifest supports wire management in an organized wire management basket that allows dual sided access to electrical. Accessories include panel dividers in 3Form, wood, laminate or tack boards, as well as optional shelving and pedestals. Work surface tops are also available in wood or laminate. Visit www.agati.com to view more options.



Six person zig-zag workstation with 3Form dividers.



AGATI is defined by versatility. Designs combine a unique blend of aesthetics and engineering, distinguished by their eclectic styles. Inspired by the need for furniture that is both timeless and universal, AGATI is committed to design and engineering of each and every piece.

Furniture built to last a lifetime means investing in the future. AGATI is dedicated to implementing sound environmental practices such as utilizing domestic reforested lumber, as well as reusable packaging materials. AGATI believes in helping preserve resources at no expense to the integrity of the product or the satisfaction of the customer.

Celebrated for its design. Chosen for its quality.



AGATI

1219 W Lake Street Chicago, Illinois 60607 T 312.829.1977 F 312.829.8249 www.agati.com

©2013 Agati, Chicago, Illinois Printed in USA 3/13_2M



The Vista Modular Bench Collection

Vista Modular Benches provide contemporary soft seating solutions. Create custom bench configurations by connecting cushioned seats and charging tables with stone tops. Mix and match seating segments, to create the length and shape that work for your space plan. Or, use the elegant standalone benches in your lounge area or touchdown space. All are on sleek 5" metal legs for easy cleaning, maintenance, and of course, style. With 10 segments to choose from, we can help you design the perfect seating for your facility.

Add-ons

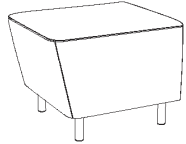

24" Add-on
24"W x 24"D x 19"H

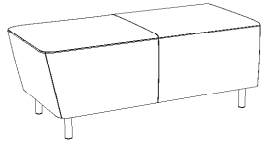

48" Add-on
48"W x 24"D x 19"H

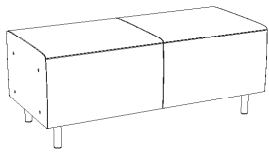

48" Middle
48"W x 24"D x 19"H

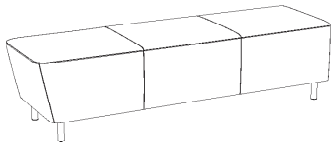

72" Add-on
72"W x 24"D x 19"H



48" Table
24"W x 22"D x 12"H

Standalone

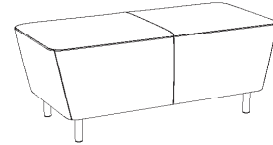

48" Bench
48"W x 24"D x 19"H

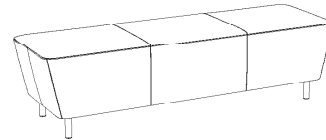

72" Bench
72"W x 24"D x 19"H

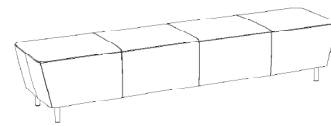

96" Bench
96"W x 24"D x 19"H

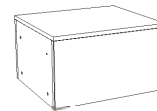

24" Table
24"W x 22"D x 12"H



ELEMENTS
MEDIA





Technology your way. Choose from one laptop connection or multiple laptop connections. Collaborate as a group, as well as with those in remote locations.



Pair the Hampton Banquette with Elements Media for comfortable, supportive seating that accommodates groups of multiple sizes. For additional seating and workspace, add a back shelf and AGATI Jet or Sensi stools.



ELEMENTS MEDIA

Elements Media features AGATI's Hampton Seating, which answers the call for effective, yet creative use of space. Accommodating groups of all sizes, both the round and straight Hampton banquettes can be used with Elements Media. Add optional surrounds covered in fabric or sleek veneers for ultimate privacy.

Technology is an ever changing landscape; AGATI adapts its furniture to meet these changes head on while maintaining the integrity of its original design.

Visit www.agati.com to see more.



The optional switching system allows multiple users to share access with the touch of a button.



AGATI is defined by versatility. Designs combine a unique blend of aesthetics and engineering. Inspired by the need for furniture that is both timeless and universal, AGATI is committed to the design and engineering of each and every piece.

Furniture built to last a lifetime means investing in the future. AGATI is dedicated to implementing sound environmental practices such as utilizing domestic reforested lumber, as well as reusable packaging materials. AGATI believes in helping preserve resources at no expense to the integrity of the product or the satisfaction of the customer.

Celebrated for its design. Chosen for its quality.



AGATI

1219 W Lake Street Chicago, Illinois 60607 T 312.829.1977 F 312.829.8249 www.agati.com

©2014 AGATI, Chicago, Illinois

ANTRIM





Antrim Table in maple with inset Marmoleum top and Stardust Silver finish.

Knife Edge Profile



Square Edge Profile



Heavy Edge Profile



Updated Leveler



Antrim Table in maple, Antrim Chairs with casters.

Antrim Carrel in maple with wire chase leg option, below left. Antrim Stacking Chairs, below right.





Columbia University Health Sciences Library, Hammer Teaching & Learning Center

ANTRIM Collection

The Antrim Collection's distinctive "floating" work surface features a standard upswept knife edge profile, as well as optional square and heavy edge profiles. The cold-rolled steel base is sealed with a durable, eco-friendly powder coat finish. The Antrim Collection is available in a wide variety of materials and finishes including wood veneers, plastic laminates and Marmoleum® insets.

Technology management solutions include power and data connections with wirec hase leg enclosures. Paired with innovative lighting, the Antrim Collection is designed to enhance its environment, while fulfilling modern technology needs. The collection includes study tables, carrels, occasional tables, chairs, benches and endpanels. Visit www.agati.com to see more.



Antrim Bench



Oak Park Public Library,
Open Book Cafe



The City College of New York, Spitzer School of Architecture.



Side Chair



Study Table



Occasional Table

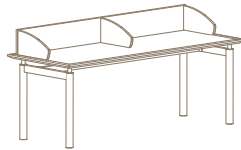

able Carrel

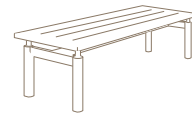

Bench



End Panel

AGATI is defined by versatility. Designs combine a unique blend of aesthetics and engineering, distinguished by their eclectic styles. Inspired by the need for furniture that is both timeless and universal, AGATI is committed to the design and engineering of each and every piece.

Furniture built to last a lifetime means investing in the future. AGATI is dedicated to implementing sound environmental practices such as utilizing domestic reforested lumber, as well as reusable packaging materials. AGATI believes in helping preserve resources at no expense to the integrity of the product or the satisfaction of the customer.

Celebrated for its design. Chosen for its quality.



AGATI

1219 W Lake Street Chicago, Illinois 60607 T 312.829.1977 F 312.829.8249 www.agati.com

©2010 AGATI, Chicago, Illinois Printed in USA 11/10_3M

ROLAND



AGATI
FURNITURE



Roland Carrel with shelf and lighting options.



Roland Round Study Table with maple top.



Round Study Table with cherry top and lighting option.



Roland Round Bench with upholstered seat.



Roland Bench with upholstered seats and inset granite table.



Roland Occasional Table with granite top.



Roland Conference Table shown with data port option.

ROLAND Collection

A modern display of wood and metal, the Roland Collection epitomizes today's forward, contemporary design. The collection maintains a striking presence with its stylish, modern design. Stainless steel bases support the Roland's floating work surface for an uncluttered, clean profile. Tables feature an inset wood veneer top with a solid wood square edge. The Roland's thin straight leg and apron rails add to its modest and fresh appeal.

The Roland Collection answers the call for today's functional needs in everyday, modern settings. Well suited for contemporary spaces, the Roland can accommodate today's technological needs. Add glass or wood dividers for more institutional environments. The Roland Collection includes study tables, occasional tables, carrels, benches and end panels. Visit www.agati.com to see more.





Roland Study Tables

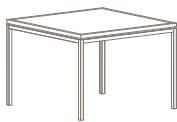

StudyTable

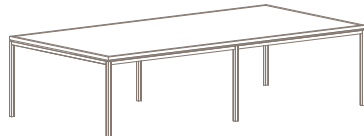

Conference Table



Round Occasional Table



End Panel

AGATI is defined by versatility. Designs combine a unique blend of aesthetics and engineering, distinguished by their eclectic styles. Inspired by the need for furniture that is both timeless and universal, AGATI is committed to the design and engineering of each and every piece.

Furniture built to last a lifetime means investing in the future. AGATI is dedicated to implementing sound environmental practices such as utilizing domestic reforested lumber, as well as reusable packaging materials. AGATI believes in helping preserve resources at no expense to the integrity of the product or the satisfaction of the customer.

Celebrated for its design. Chosen for its quality.



AGATI

1219 W Lake Street Chicago, Illinois 60607 T 312.829.1977 F 312.829.8249 www.agati.com

©2013 AGATI, Chicago, Illinois Printed in USA 3/13_2M

**ROLAND
COURTROOM**



Judges Table



Courtroom Podium



Witness Stand



Counsel Table

The Roland Courtroom Collection

The Roland Collection Courtroom Suite includes Judge's Bench, Lectern, two Witness Stands, and two Attorney Tables. AGATI's Roland Collection maintains a striking presence with its stainless steel bases and stylish, modern design.

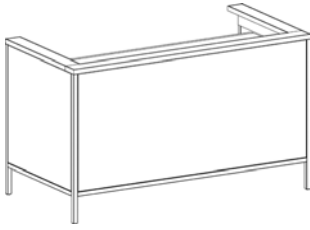

Judges Table
60-84"W 36"D 42"H
36"H Worksurface

Power Optional

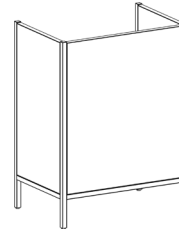

Courtroom Podium
36"W 24"D 48"H
42"H Worksurface

Power Optional

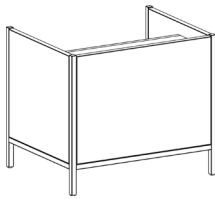

Witness Stand
38"W 30"D 33"H
30"H Worksurface

Power Optional



Counsel Table
60-84"W 36-42"D 30"H
30"H Worksurface

Power Optional



BROWN



AGATI
FURNITURE



Brown Panel Carrel with metal reveals.

Brown Panel Tables with reveal options, below and right, shown with Ella Arm Chair.





Brown Leg Base Study Table with data port option.

BROWN Collection

The Brown Collection makes a bold statement with a design motif achieved through the use of reveals. Horizontal and vertical reveal details accent table base ends, showcasing a strong, clean line design. Originally designed for the U.S. Courthouse Libraries, the Brown Collection featured contemporary solid wood, panel tables. Inset wood veneer tops and solid wood square edges grace each table giving the collection its handsome yet simple style.

Melding metal and wood, the Brown Collection bridges the gap between traditional and contemporary. Optional metal reveals serve to highlight the Brown Collection's flawless lines and solid construction. Striking and enduring, the Brown Collection includes study tables, book tables, carrels, atlas and dictionary stands, end panels, shelving and reference desks. Visit www.agati.com to see more.





Brown Study Tables with Curtis Chairs. Augustana College, Souix Falls, SD.

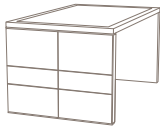

Panel Study Table

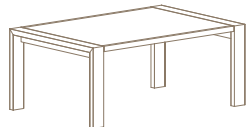

Leg Base Study Table

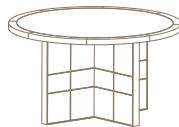

Round X-Base Table

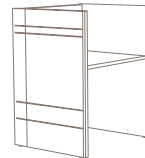

Panel Carrel



End Panel

AGATI is defined by versatility. Designs combine a unique blend of aesthetics and engineering, distinguished by their eclectic styles. Inspired by the need for furniture that is both timeless and universal, AGATI is committed to the design and engineering of each and every piece.

Furniture built to last a lifetime means investing in the future. AGATI is dedicated to implementing sound environmental practices such as utilizing domestic reforested lumber, as well as reusable packaging materials. AGATI believes in helping preserve resources at no expense to the integrity of the product or the satisfaction of the customer.

Celebrated for its design. Chosen for its quality.



AGATI

1219 W Lake Street Chicago, Illinois 60607 T 312.829.1977 F 312.829.8249 www.agati.com

©2010 Agati, Chicago, Illinois Printed in USA 12/10_2M

**BROWN
COURTROOM**



Judges Table



Courtroom Podium



Witness Stand



Counsel Table

The Brown Courtroom Collection

The Brown Collection Courtroom Suite includes Judge's Bench, Lectern, two Witness Stands, and two Attorney Tables. AGATI's Brown Collection makes a bold statement with a design motif achieved through the use of reveals.

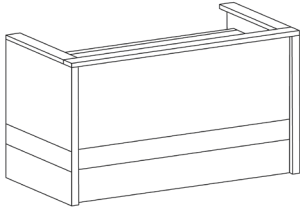

Judges Table
60-84"W 36"D 42"H
36"H Worksurface

Power Optional

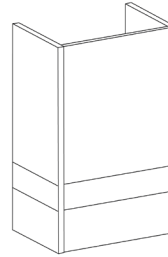

Courtroom Podium
36"W 24"D 48"H
42"H Worksurface

Power Optional

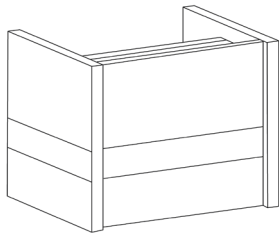

Witness Stand
38"W 30"D 33"H
30"H Worksurface

Power Optional

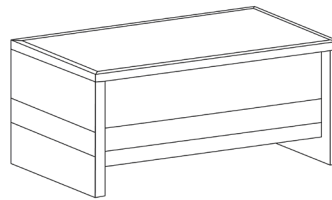

Counsel Table
60-84"W 36-42"D 30"H
30"H Worksurface

Power Optional



CERINO





Cerino Round Study Table in maple with square edge, shown with Baja chair, top.



Square Study Table in maple with inset Marmoleum top and data port option, center.



Cerino Study Carrel with lighting option, left.

Modified upholstered bench, below right.





Cerino Rectangular Study Table in cherry.

CERINO Collection

The Cerino Collection is universal in both appeal and design. Streamlined and stylish, Cerino complements its setting. The collection is functional and durable, without overpowering its surroundings or accompanying furniture.

Cerino tables and carrels feature heavy, solid wood, tapered legs with a routed foot detail on the bottom of the legs. Tops are available with either wood veneer or Marmoleum insets with a solid wood, chamfered edge or a square edge. All Cerino tables and carrels support data and power needs, as well.

The Cerino Collection includes study tables, occasional tables, benches and carrels. It also adapts well to children's areas. Visit www.agati.com for more options.





Cerino Carrels, Tables and Self-check station. Jet side chairs.



Square Study Table



Round Table



Study Carrel

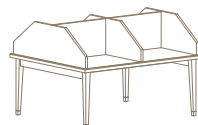

Dual Face Table Carrel



Children's Table

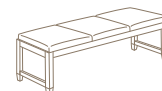

3-Seat Bench

AGATI is defined by versatility. Designs combine a unique blend of aesthetics and engineering, distinguished by their eclectic styles. Inspired by the need for furniture that is both timeless and universal, AGATI is committed to the design and engineering of each and every piece.

Furniture built to last a lifetime means investing in the future. AGATI is dedicated to implementing sound environmental practices such as utilizing domestic reforested lumber, as well as reusable packaging materials. AGATI believes in helping preserve resources at no expense to the integrity of the product or the satisfaction of the customer.

Celebrated for its design. Chosen for its quality.



AGATI

1219 W Lake Street Chicago, Illinois 60607 T 312.829.1977 F 312.829.8249 www.agati.com

©2013 Agati, Chicago, Illinois Printed in USA 3/13_2M

WILLIAMS





Williams Study Table
in maple, left.



Williams Study Carrel
in maple.



Williams Table Carrel in maple
with inset Marmoleum top,
shown with Ella Chair, center.



Williams Display Tables.



Williams Bench



Canton Public Library, Canton, MI

WILLIAMS Collection

Parallel lines and crisp angles give the AGATI Williams Collection its contemporary flair. Constructed from solid wood, the Williams Collection adds modern appeal while retaining the warmth of wood furniture.

Streamlined and functional, the collection complements, rather than dominates, its environment. Williams tables feature flush end apron rails, end and center stretchers and are supported by solid wood bases and straight legs.

The Williams Collection includes study tables, occasional tables, carrels, table carrels with divider options and benches. Visit agati.com to see more.





University of North Florida

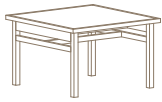

Square Study Table



Rectangular Study Table

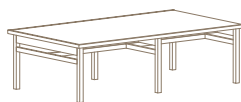

Conference Table



Round X-base Table

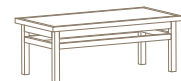

Occasional Table

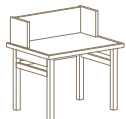

Study Carrel

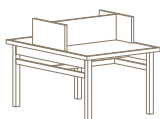
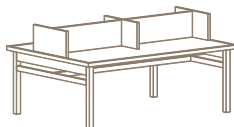
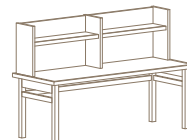

Table Carrel



4-Person Double Face
Table Carrel



Index Table



Bench

AGATI is defined by versatility. Designs combine a unique blend of aesthetics and engineering, distinguished by their eclectic styles. Inspired by the need for furniture that is both timeless and universal, AGATI is committed to the design and engineering of each and every piece.

Furniture built to last a lifetime means investing in the future. AGATI is dedicated to implementing sound environmental practices such as utilizing domestic reforested lumber, as well as reusable packaging materials. AGATI believes in helping preserve resources at no expense to the integrity of the product or the satisfaction of the customer.

Celebrated for its design. Chosen for its quality.



AGATI

1219 W Lake Street Chicago, Illinois 60607 T 312.829.1977 F 312.829.8249 www.agati.com

©2013 AGATI, Chicago, Illinois Printed in USA 3/13_2M

CHARLES





Left: Charles Lounge Chairs with square splat detail, left, and with dentil detail, right.



Bottom: Charles Triple Seat Bench with upholstered seat, and Occasional Table.





Charles Study Table shown with Charles Side Chair.

CHARLES Collection

The Charles Collection finds its inspiration in the crisp, design details of 20th century architect, designer and artist, Rennie Mackintosh. Featuring a “three square” motif integral to Mackintosh’s design vocabulary, the Charles Collection is quickly identified by its pierced cutouts or applied squares.

Evocative of Mission style’s dignified integrity and fluid lines, the Charles Collection showcases a decorative, solid wood frame. Completing the Charles Collection are chairs, benches, lounge chairs, tables, occasional tables, carrels, dictionary and atlas stands, and end panels. Visit www.agati.com to see more options.

Charles Collection also includes children’s table and chairs.





Coralville Public Library, Coralville, IA.

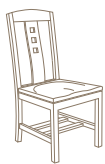

Side Chair

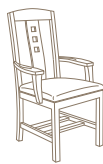

Arm Chair

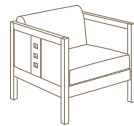

Lounge Chair

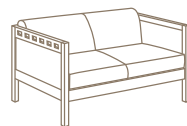

Two Seat Sofa

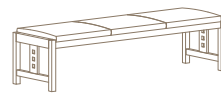

Bench

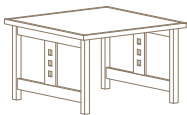

Study Table

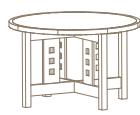

X-Base Table



Occasional Table

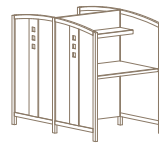

Double Faced Carrel



Atlas Stand



End Panel

AGATI is defined by versatility. Designs combine a unique blend of aesthetics and engineering, distinguished by their eclectic styles. Inspired by the need for furniture that is both timeless and universal, AGATI is committed to the design and engineering of each and every piece.

Furniture built to last a lifetime means investing in the future. AGATI is dedicated to implementing sound environmental practices such as utilizing domestic reforested lumber, as well as reusable packaging materials. AGATI believes in helping preserve resources at no expense to the integrity of the product or the satisfaction of the customer.

Celebrated for its design. Chosen for its quality.



AGATI

1219 W Lake Street Chicago, Illinois 60607 T 312.829.1977 F 312.829.8249 www.agati.com

© 2010 AGATI, Chicago, Illinois Printed in USA 12/10_2M



Judges Table



Courtroom Podium



Witness Stand



Counsel Table

The Charles-DePaul Courtroom Collection

We merged the best elements from our two most popular transitional styles in the Charles-DePaul Courtroom Suite. Pulling from the popularity of the center-splat style found in the Charles Collection, we maintained the elegance of simplicity, as epitomized in the DePaul Collection to design the Charles-DePaul Courtroom Suite.

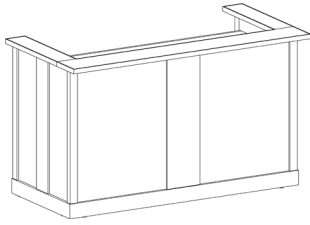

Judges Table
60-84"W 36"D 42"H
36"H Worksurface

Power Optional

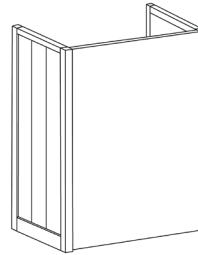

Courtroom Podium
36"W 24"D 48"H
42"H Worksurface

Power Optional

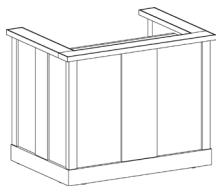

Witness Stand
38"W 30"D 33"H
30"H Worksurface

Power Optional

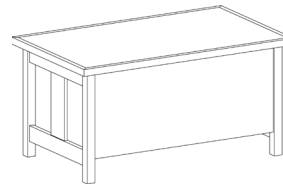

Counsel Table
60-84"W 36-42"D 30"H
30"H Worksurface

Power Optional



DEPAUL





DePaul Armchair
with upholstered seat and
Side Chair.



DePaul Round
X-Base Table.



DePaul Armless
Back Bench in cherry.



DePaul Back Bench
with arms in maple.



DePaul Study Table and Side Chair.

DE PAUL Collection

The DePaul Collection exemplifies transitional design. Starting with classic, traditional design and adding a twist of contemporary, the DePaul Collection is one of Agati's most popular collections. Originally designed for the DePaul University Law Library Project, the collection emphasizes the inherent qualities of the wood grain, the elegance of the design's simplicity and the importance of craftsmanship.

Generous, vertical lines adorn a trestle base construction. DePaul tables emphasize their stepped, vertical detail showcasing classic design with a modern flair. Solid wood chair and bench frames feature vertical back slats, side leg and double center stretchers. Chairs come in either carved wood saddle seats or upholstered slip seats.

The DePaul Collection includes chairs, study tables, carrels, a variety of benches, dictionary and atlas stands, plus end panels. Visit www.agati.com to see more.





DePaul University Law Library, Chicago, IL



Side Chair



Arm Chair

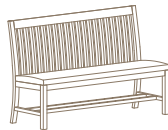

Back Bench

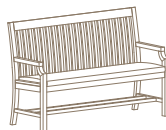

Back Bench with Arms



Upholstered Bench

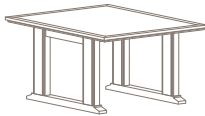

Study TableR



ound Table

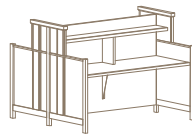

Double Face Carrel

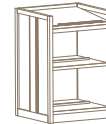

Dictionary & Atlas Stand

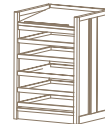

End Panel

AGATI is defined by versatility. Designs combine a unique blend of aesthetics and engineering, distinguished by their eclectic styles. Inspired by the need for furniture that is both timeless and universal, AGATI is committed to the design and engineering of each and every piece.

Furniture built to last a lifetime means investing in the future. AGATI is dedicated to implementing sound environmental practices such as utilizing domestic reforested lumber, as well as reusable packaging materials. AGATI believes in helping preserve resources at no expense to the integrity of the product or the satisfaction of the customer.

Celebrated for its design. Chosen for its quality.



AGATI

1219 W Lake Street Chicago, Illinois 60607 T 312.829.1977 F 312.829.8249 www.agati.com

©2014 AGATI, Chicago, Illinois Printed in USA

FRYE





Frye Round Study Table, and Occasional Table with foot blocks, above.

Frye Double Seat Bench with upholstered seat, left.



Frye Low Back Lounge Chairs, and Occasional Table, below.



Abraham Lincoln Presidential Library, Springfield, IL

FRYE collection

The Frye Collection typifies the Arts and Crafts movement. Reflective of its 19th century elegance, the Frye Collection is simple in design and reliable in construction. Tables are made out of solid wood frames with end slats. Lounge chairs provide upholstered seats and backs and come in both high or low back versions. Two and three seat sofas are also available.

A modest, welcoming collection that doesn't overpower its setting, the Frye Collection includes study tables, carrels, benches, lounge chairs, occasional tables and display items. Visit www.agati.com to see more.



Frye Pull Up Chair



Fry Two Person Study Carrel with foot block option.



Lounge Chair

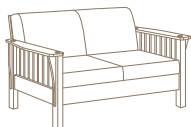

Two Seat Sofa

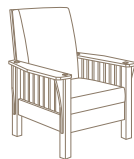

High Back Lounge Chair

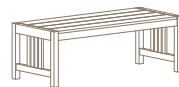

Bench



Occasional Table

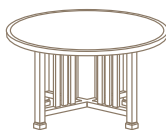

Round Study Table

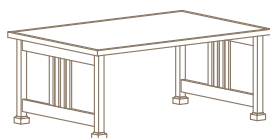

Rectangular Study Table

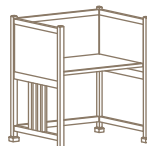

Study Carrel

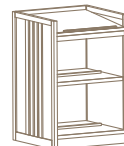

Dictionary and Atlas Stands

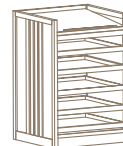

End Panel

AGATI is defined by versatility. Designs combine a unique blend of aesthetics and engineering, distinguished by their eclectic styles. Inspired by the need for furniture that is both timeless and universal, AGATI is committed to the design and engineering of each and every piece.

Furniture built to last a lifetime means investing in the future. AGATI is dedicated to implementing sound environmental practices such as utilizing domestic reforested lumber, as well as reusable packaging materials. AGATI believes in helping preserve resources at no expense to the integrity of the product or the satisfaction of the customer.

Celebrated for its design. Chosen for its quality.



AGATI

1219 W Lake Street Chicago, Illinois 60607 T 312.829.1977 F 312.829.8249 www.agati.com

©2010 Agati, Chicago, Illinois Printed in USA 12/10_2M

MYLES





Myles Double Faced Table
Carrel, in cherry, with
inset Marmoleum top, left.



Myles Round X-Base
Study Table, center.



Myles Study Table shown
with Prairie chair, below.



Lexington Public Library, Lexington, NE

MYLES Collection

The AGATI Myles Collection can attribute its beauty to its simple lines and modest design. Influenced by Arts and Crafts styling, the Myles Collection features solid wood, triple slat detail set against a solid wood frame and panel construction.

Carrels feature three-fourths height end panels and overhead storage shelves. The Myles Collection's clean, unobtrusive design allows collection pieces to blend with their environment and coordinate seamlessly with other AGATI Collections.

The Myles Collection includes a large selection of study tables, occasional tables, carrels, atlas and dictionary stands, benches, stools and end panels. Visit www.agati.com to view more.



Myles Lounge Chair



Myles 4-person double faced Study Carrel

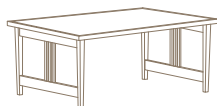

Study Table

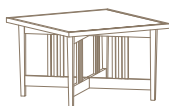

X-Base Study Table



Round Study Table

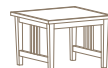

Square Occasional



Round Occasional



End Panel

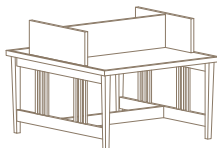
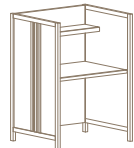
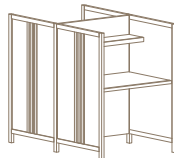

Table Carrel



Carrel



Double Face Carrel

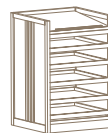

Atlas Stand

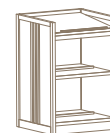

Dictionary Stand

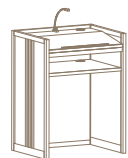

Podium

AGATI is defined by versatility. Designs combine a unique blend of aesthetics and engineering, distinguished by their eclectic styles. Inspired by the need for furniture that is both timeless and universal, AGATI is committed to the design and engineering of each and every piece.

Furniture built to last a lifetime means investing in the future. AGATI is dedicated to implementing sound environmental practices such as utilizing domestic reforested lumber, as well as reusable packaging materials. AGATI believes in helping preserve resources at no expense to the integrity of the product or the satisfaction of the customer.

Celebrated for its design. Chosen for its quality.



AGATI

1219 W Lake Street Chicago, Illinois 60607 T 312.829.1977 F 312.829.8249 www.agati.com

©2013 AGATI, Chicago, Illinois Printed in USA 3/13_2M

GOTHIC



Gothic Study Carrel with
Gothic Armchair, right.
Gothic Square Study Table
with lattice detailing, below.



Gothic Trestle Table
with Gothic Side Chair





Duke University Chapel, Durham, NC

Bryan Becker Photography

GOTHIC collection

Designed in response to the University of Chicago's Hutchinson Commons Project, the Gothic Collection is a study in detail. Harkening back to 12th century Cathedral Design, the Gothic is a visually rich collection.

Solid wood frames are embellished by a quatrefoil detail or a beautiful lattice design which adds detail and provides a source of light and openness to the pieces. Skillfully designed, the Collection's elegance belies its structure. Chairs and tables feature solid wood frames and are constructed to endure. The Gothic designs etched into each piece make the collection recognizable for its beauty and character.

The Gothic Collection includes chairs, lounge chairs, study tables, occasional tables, carrels, dictionary and atlas stands and end panels.





Boston College, Stokes Hall, Boston, MA



Side Chair



Arm Chair

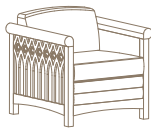

Lounge Chair



Round Study Table

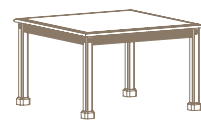

Square Study Table

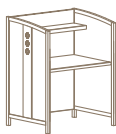

Carrel

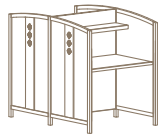

Double Faced Carrel



Atlas Stand



Dictionary Stand



End Panel

AGATI is defined by versatility. Designs combine a unique blend of aesthetics and engineering, distinguished by their eclectic styles. Inspired by the need for furniture that is both timeless and universal, AGATI is committed to the design and engineering of each and every piece.

Furniture built to last a lifetime means investing in the future. AGATI is dedicated to implementing sound environmental practices such as utilizing domestic reforested lumber, as well as reusable packaging materials. AGATI believes in helping preserve resources at no expense to the integrity of the product or the satisfaction of the customer.

Celebrated for its design. Chosen for its quality.



AGATI

GOTHIC
COURTROOM



Judges Table



Courtroom Podium



Witness Stand



Counsel Table

The Gothic Courtroom Collection

The Gothic Collection Courtroom Suite includes Judge's Bench, Lectern, two Witness Stands, and two Attorney Tables. AGATI's Gothic Collection is distinguished by an intricate quatrefoil and lattice designs etched into each piece making it recognizable for its beauty and character.

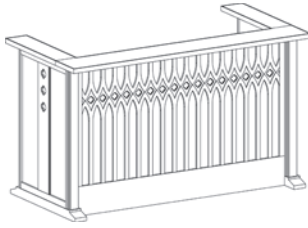

Judges Bench
60-84"W 36"D 42"H
36"H Worksurface

Power Optional



Podium
36"W 24"D 48"H
42"H Surface

Power Optional

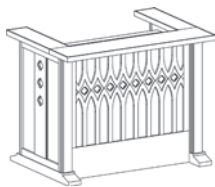

Witness Stand
38"W 30"D 33"H
30"H Worksurface

Power Optional

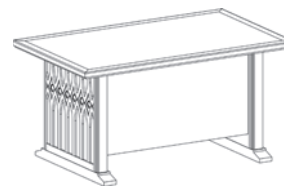

Counsel Table
60-84"W 36-42"D 30"H
36"H Worksurface

Power Optional



GRANT
COURTROOM



Judges Table



Courtroom Podium



Witness Stand



Counsel Table

The Grant Courtroom Collection

The Grant Collection Courtroom Suite delivers the essential courtroom furniture—Judge’s Bench, Lectern, Witness Stands, and Attorney Tables—universities, schools, and mock courtrooms need at a practical price point. Its cost-effective, panel-based design is constructed from plastic laminate with PVC edge banding for durability. Grant can be specified with casters for multi-use flexibility. Caster mount also provides a bumper guard for added protection.

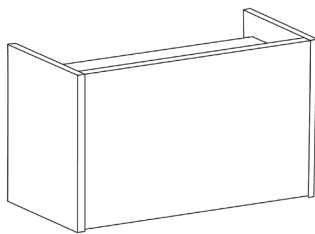

Judges Table
60-84"W 36"D 42"H
36"H Worksurface

Power Optional
Casters Optional

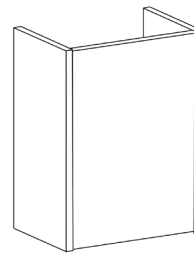

Courtroom Podium
36"W 24"D 48"H
42"H Worksurface

Power Optional
Casters Optional

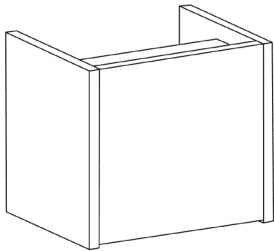

Witness Stand
38"W 30"D 33"H
30"H Worksurface

Power Optional
Casters Optional

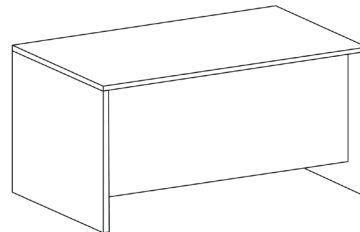

Counsel Table
60-84"W 36-42"D 30"H
30"H Worksurface

Power Optional
Casters Optional



PRIMARY



AGATI
FURNITURE



Primary Study Table in maple, above.
Primary Study Carrel, right.



Primary Librarian Desk, with Marmoleum top,
above, shown with Behrmann Chair.
Primary Pedestal Filing Cabinets.
Also see our Primary Shelving brochure
for additional storage options.





Primary Modular Circulation Desk with Corner Units.

PRIMARY Collection

The AGATI Primary Collection was born out a need for the essentials. A collection of simply designed yet beautifully built furniture, the Primary Collection strives to meet budgets without sacrificing style. Ideal for the primary education sector where superfluous furniture need not apply, the Primary Collection highlights affordability and flexibility. Pair a Primary desk with file cabinet pedestals or configure the modular circulation desk to meet any size space. This collection of furniture proves to be space conscientious and durable enough for the everyday use of educational environments.

Available in standard AGATI finishes, the Primary Collection boasts study tables, carrels, a variety of desks, shelving and storage units. The AGATI Ella, Prairie and Behrmann chairs are often chosen to complement the Primary Collection. Visit www.agati.com to see more.

Primary Round Childrens Table with Behrmann Chairs in maple.





Primary Round Study Table in Cherry with Ella Slat Back Side Chairs.



Round Study Table

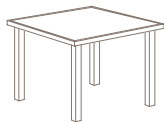

Square Study Table



Librarian Desk



Lateral File Cabinet



Pedestal File Cabinet

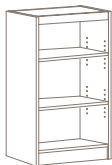

Single Face
Shelving Unit



Double Face
Shelving Unit

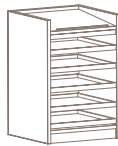

Atlas & Dictionary
Stands

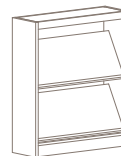

Periodical Shelving



Wardrobe

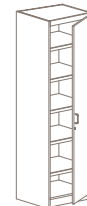

Storage Closet

AGATI is defined by versatility. Designs combine a unique blend of aesthetics and engineering, distinguished by their eclectic styles. Inspired by the need for furniture that is both timeless and universal, AGATI is committed to the design and engineering of each and every piece.

Furniture built to last a lifetime means investing in the future. AGATI is dedicated to implementing sound environmental practices such as utilizing domestic reforested lumber, as well as reusable packaging materials. AGATI believes in helping preserve resources at no expense to the integrity of the product or the satisfaction of the customer.

Celebrated for its design. Chosen for its quality.



AGATI

1219 W Lake Street Chicago, Illinois 60607 T 312.829.1977 F 312.829.8249 www.agati.com

©2010 Agati, Chicago, Illinois Printed in USA 12/10_2M

PRIMARY SHELVING & STORAGE



Shelf clip detail

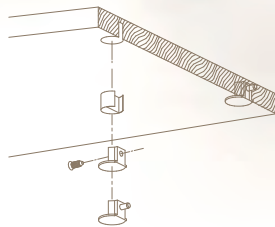

Shelf pivots up for storage

Leveling glides easily accessible through bottom shelf.

TOPCAP EDGE PROFILES



Crown Edge



Stepped Edge



Rounded Edge



Square Edge (Standard)

The AGATI Primary Collection was born out a need for the essentials. A collection of simply designed yet beautifully built furniture, the Primary Collection strives to meet budgets without sacrificing style.

Primary shelving and storage units are available in standard AGATI finishes. Shelving units are designed to withstand years of use and maintain a timeless aesthetic. Single units feature front facing shelves and a finished back while double face units provide more shelving and a finished center panel.

The Primary collection also includes study tables, carrels, desks, storage and display items.

AGATI
FURNITURE

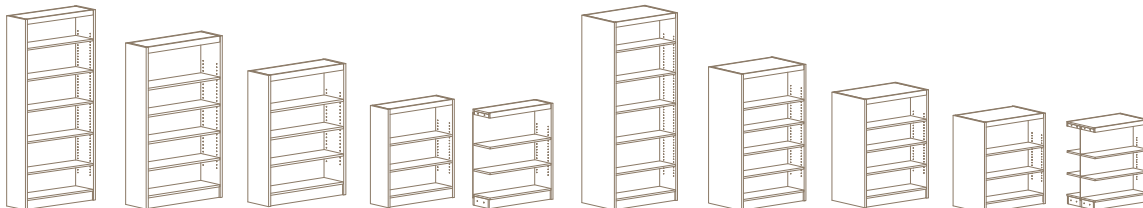

Single Face Units
36w x 12d Starter and Adder Units

Double Face Units
36w x 22d Starter and Adder Units

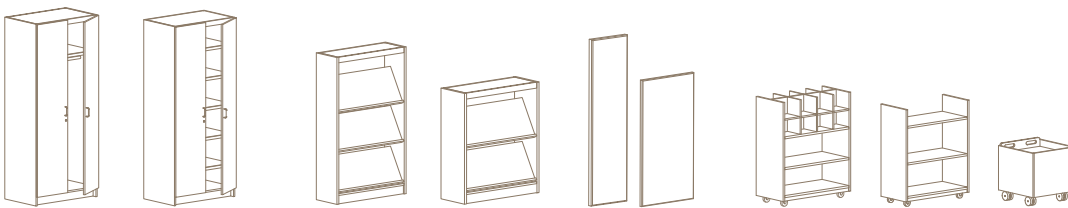

Wardrobe

Storage Cabinet

Periodical Display

End Panels

Bookcarts and Booktrucks

AGATI is defined by versatility. Designs combine a unique blend of aesthetics and engineering, distinguished by their eclectic styles. Inspired by the need for furniture that is both timeless and universal, AGATI is committed to the design and engineering of each and every piece.

Furniture built to last a lifetime means investing in the future. AGATI is dedicated to implementing sound environmental practices such as utilizing domestic reforested lumber, as well as reusable packaging materials. AGATI believes in helping preserve resources at no expense to the integrity of the product or the satisfaction of the customer.

Celebrated for its design. Chosen for its quality.



AGATI

BAJA



The Baja Chair is a versatile, modern chair that offers a sloping, generous seat pan and a comfortable sit. A stylish back panel provides an abundant amount of back support. Its solid wood frame is complemented by formed wood veneer seat and back panels.

The Baja Chair is also available as an armchair and a stool. It is available in three finishes: maple, cherry or espresso. It can also feature an upholstered seat. An optional book rack beneath the seat makes the Baja Chair ideal for individual seating in places of gathering. Visit www.agati.com to see more.



Baja Chair



Baja Chair,
upholstered seat



Baja Arm Chair



Baja Counter Stool



Baja High Stool

AGATI is defined by versatility. Designs combine a unique blend of aesthetics and engineering, distinguished by their eclectic styles. Inspired by the need for furniture that is both timeless and universal, AGATI is committed to the design and engineering of each and every piece.

Furniture built to last a lifetime means investing in the future. AGATI is dedicated to implementing sound environmental practices such as utilizing domestic reforested lumber, as well as reusable packaging materials. AGATI believes in helping preserve resources at no expense to the integrity of the product or the satisfaction of the customer.

Celebrated for its design. Chosen for its quality.



AGATI

1219 W Lake Street Chicago, Illinois 60607 T 312.829.1977 F 312.829.8249 www.agati.com

©2016 AGATI, Chicago, Illinois Printed in USA 3/13_2M

Sensi Collection

Pull Up Chair and Stool



Sensi Pull Up Chair



Sophisticated Support

The Sensi Pull Up Chair combines modern style with comfort. A gently reclined back and built-in lumbar support make this bent plywood chair surprisingly comfortable to sit in. Clean lines and a slim profile make this side chair a natural fit with almost any style. Extremely durable, the Sensi Collection stands up in the busiest public spaces.

Versatility by Design

Designed for easy stacking—up to five chairs—Sensi Pull Up Chair offers convenient storage when space matters. The laminate Sensi chair is available in a variety of plastic laminate colors and tones. The wood Sensi chair offers maple finished clear or stained to match. Choose from a chrome or metallic silver base.



PRODUCT LINE



Sensi Pull Up Chair
• 19.5"W x 21.75"D x 34.25"H

SPECIFICATIONS

Material Options

Laminate
Wood

Base Finishes

Chrome Base
Metallic Silver Base

Other Options

Wood can be stained to match specifier's sample
For laminate color options please reference our resources page:
<https://www.agati.com/resources/>

Sensi Stool



Sophisticated Support

The Sensi Stool combines modern style with comfort. A gently reclined back and built-in lumbar support make this bent plywood stool surprisingly comfortable to sit in. Clean lines and a slim profile make this stool a natural fit with almost any style. Extremely durable, the Sensi Collection stands up in the busiest public spaces.

Versatility by Design

The laminate Sensi Stool is available in a variety of plastic laminate colors and tones. The wood Sensi Stool offers maple finished clear or stained to match. Choose from chrome or metallic silver base. Durable, yet lightweight, Sensi Stools are easy to pull up to any public space counter.

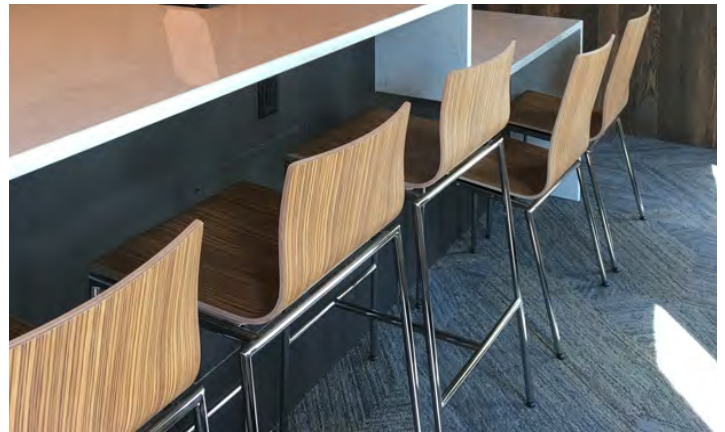

PRODUCT LINE

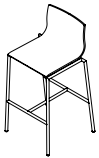

Sensi Stool
• 20.875"W x 19.25"D x 37.75"H

SPECIFICATIONS

Material Options

Laminate
Wood

Base Finishes

Chrome Base
Metallic Silver Base

Other Options

Wood can be stained to match specifier's sample
For laminate color options please reference our resources page:
<https://www.agati.com/resources/>

ALTEZZA STOOL



Altezza Stools

Altezza Stool has a simple but elegant design. Built to be extremely durable for high-traffic airport seating, the Altezza Stool is also a refined bar stool for libraries and lobbies. With a powder coat base and upholstered seat, Altezza Stool can match any environment. Choose from the option of a swivel or stationary seat. Stainless steel foot ring makes the stool extremely durable, not to mention it's a beautiful accent. This disc base stool was designed to support our Power Bar/Table Collection.

Specifications

Height:	29" or 18"
Base:	Choose from Agati standard powder coat options
Foot ring:	Stainless steel
Seat:	Upholstered Choose from swivel or stationary

*Capability to bolt to floor

Bar Height

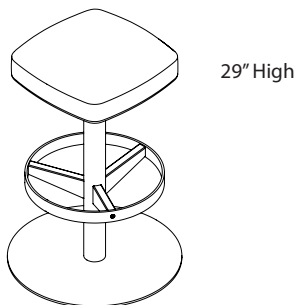
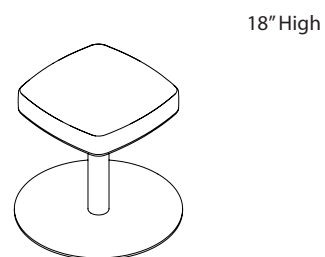

Table Height



AGATI
FURNITURE

FAN



AGATI's Fan is a unique armchair noticed immediately for its distinctive character. An elegant shell shape seat featuring precise stitching is its most striking feature. The Fan Chair epitomizes the modern arm chair, best used in open spaces, conference rooms, receptions and home offices. The shell is made of a high quality cold melded foam technology supported by a sleek, chrome disc base with a self-centering cylinder. Fan is available in a variety of colors and fabrics, with contrasting stitching.

AGATI

CLASSIC
CHAIRS





CLASSIC CHAIRS

CHARLES

Inspired by the crisp design details of Charles Rennie Mackintosh. Solid wood frame, three square motif on back splat. Arm or armless with carved wood or upholstered seat. Also available as a bench.



DEPAUL

The DePaul collection emphasizes the inherent qualities of the wood grain, the elegance of the design's simplicity, and the importance of craftsmanship.

Solid wood frame with vertical back slats. Arm or armless with carved wood or upholstered seat. Also available in a variety of bench options.



GOTHIC

The Gothic is a study in detail, but it's elegance belies its structure. Gothic chairs are solidly constructed, yet maintain a sense of airiness with its lattice design.

Solid wood frame with a quatrefoil detail on back splat. Arm or armless with carved wood or upholstered seat. Also available as a bench.



BEHRMANN

The Behrmann provides a solidly constructed chair – straightforward and simply designed. Use as a side wood chair or upholster for style and comfort. The modest design of the Behrmann chair makes it very adaptable.

Solid wood frame with vertical back slats, leg stretchers with bookrack, and modified arched top back rail. Carved wood saddle seat or upholstered slip seat.



PRAIRIE

Drawing on the Midwest's Prairie School of Architecture, these simple and well-designed chairs are a popular favorite.

Solid wood frame with horizontal, vertical or wavy back slats. Carved wood saddle seat. Also available as a high stool.

AGATI chairs are characterized by a blend of aesthetics and engineering to create exceptional and enduring furniture. Chairs are constructed using Agati's signature mortise and tenon joinery. Each right angled joint is secured with a pin, making the strongest possible joint. To ensure superior stability, many chairs feature a one piece, solid wood back post from floor to top rail. AGATI chairs are timeless in beauty and will enhance their environments for many years to come.

AGATI's custom capabilities provide the flexibility to accommodate various projects and budgets. See our Custom Options information sheet to view some of the many options available. Many of these chairs are also available in child or youth sizes. Go to www.agati.com to view more options.

Prairie High Stool





WHITE

The White chair is designed and engineered for optimal comfort and durability. These classic chair and stool designs look great in contemporary or traditional settings year after year.

Solid wood frame with vertical back slats or single back splat with three square motif. Carved wood saddle or upholstered seat. Also available as a high stool.

Custom Chair Options

AGATI simplifies the process of working with custom modifications. Whether it is a modification to an existing collection or a new design idea; our in-house design and engineering team assists from concept to completion. Here are just a few of the custom options available. See our Custom Options sheet for more details.



BACK

Carved details
Wood inlays
Custom splats or slats
Fold down kneeler

TOP RAIL

Cutout details
Custom rails
Laser inscription

SEAT

Carved wood seat
Cloth upholstery
Leather upholstery

STRETCHERS

Custom stretchers
Book Rack
Hymnal Box

AGATI is defined by versatility. Designs combine a unique blend of aesthetics and engineering, distinguished by their eclectic styles. Inspired by the need for furniture that is both timeless and universal, AGATI is committed to the design and engineering of each and every piece.

Furniture built to last a lifetime means investing in the future. AGATI is dedicated to implementing sound environmental practices such as utilizing domestic reforested lumber, as well as reusable packaging materials. AGATI believes in helping preserve resources at no expense to the integrity of the product or the satisfaction of the customer.

Celebrated for its design. Chosen for its quality.



AGATI

1219 W Lake Street Chicago, Illinois 60607 T 312.829.1977 F 312.829.8249 www.agati.com

© 2010 AGATI, Chicago, Illinois Printed in USA 12/10_2M



Custom Chairs

AGATI chairs are characterized by a blend of aesthetics and engineering to create exceptional and enduring furniture. Standard collections vary in design from traditional to contemporary, complimenting a wide range of interiors. AGATI's custom capabilities provide the flexibility to accommodate various projects and budgets.

Chairs are constructed using AGATI's signature mortise and tenon joinery. Each right angled joint is secured with a pin, making the strongest possible joint. To ensure superior stability, many chairs feature a one piece, solid wood back post from floor to top rail.

AGATI is a nationally recognized leader in furniture design, quality and performance. AGATI chairs are timeless in beauty and will enhance their environments for many years to come.

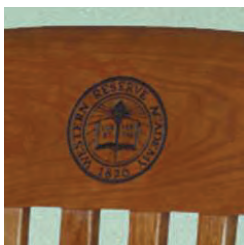

Laser Inscription



Cutout Detail

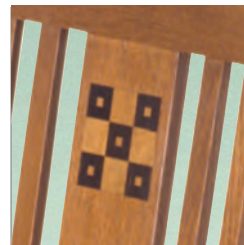

Wood Inlay



Custom Back Splats

Custom Chair Options

AGATI simplifies the process of working with custom modifications. Whether it is a modification to an existing collection or a new design idea; our in-house design and engineering team assists from concept to completion. Here are just a few of the custom options available.

Top Rail

Cutout Detail

Custom Rails

Laser Inscription



Back

Carved Details

Wood Inlays

Custom Splats or Slats



Seat

Carved Wood Seat

Cloth Upholstery

Leather Upholstery



Stretchers

Custom Stretchers

Book Rack

Hymnal Box



Wood Species and Finishes

Standard wood species include plain sliced Cherry, Maple and Red Oak. Others available upon request. Custom finishes and stain matching are also available.

AGATI

Gee Collection

Lounge Chair and Modular



Gee Lounge, Gee Straight, Gee Pinwheel, Gee Straight with Walls, Gee Modular Curve

Gee Lounge Chair



Refined Versatility

Our best selling lounge chair, the Gee adapts to any environment. A classic for its refined design, comfort and durability.

Durability

Durable materials and maintenance-focused engineering ensure that the Gee Lounge Chair maintains its structural integrity, comfort, and appearance over time. Serviceable components allow for easy cleaning, replacement and maintenance, extending the product's lifecycle.

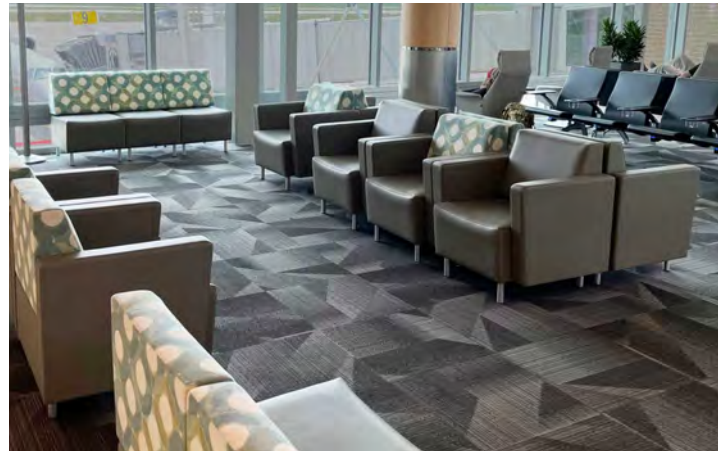

PRODUCT LINE



Lounge Chair Two-Arms
• 31" W x 29"D x 33"H



Lounge Chair Arms With Screen
• 31" W x 30.75"D x 48"H



Lounge Chair Armless
• 23" W x 29"D x 33"H

SPECIFICATIONS

Fabric Options

Standard Fabric Finishes

Base Finishes

Anodized Aluminum

Powdercoats

Powdercoating may be added for an additional upcharge

Add-ons

Non-locking casters

Power

Tablet arm - oval or rectangular available

Ge Modular



The Personal Sanctuary

The Gee Aviation – Pinwheel is a popular airport solution that balances privacy with spatial efficiency. Its unique orientation provides each traveler with dedicated workspace, power, and a clear line of sight. For enhanced focus, optional walls can be added to reduce noise and visual distractions, creating a serene sanctuary within busy terminals.

Dynamic Versatility

The Gee – Curve balances VIP comfort with high-traffic durability. Whether creating long retreats in expansive walkways or wrapping around columns in tight footprints, its adaptable design turns architectural challenges into seating opportunities.



Endless Configurations

The Gee Collection is designed for total flexibility, allowing you to tailor layouts to the specific flow of your environment. Its modular components can be arranged in endless configurations, from expansive straight runs to intricate, winding curves that maximize seating in unique footprints.

PRODUCT LINE

SPECIFICATIONS



Configuration - Straight
• 31" W x 29"D x 33"H

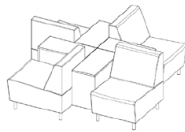

Configuration - Pinwheel
• 23" W x 29"D x 33"H

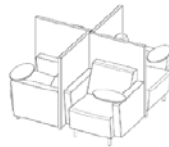

Configuration - Pinwheel with walls
• 31" W x 30.75"D x 48"H

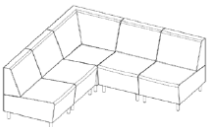

Configuration - Corner
• 23" W x 29"D x 33"H

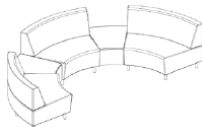

Configuration - Curve
• 126" W x 63"D x 33"H

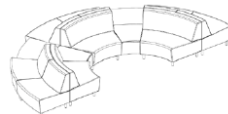

Configuration - Curve Double
• 184" W x 92"D x 33"H

Fabric Options

Standard Fabric Finishes

Base Finishes

Anodized Aluminum

Powdercoats

Powdercoating may be added for an additional upcharge

Add-ons

Non-locking casters

Power

Tablet arm - oval or rectangular available



Seamless Connectivity

Gee Tables expand the basic Gee Lounge and add functionality. Recharge with option to build in power. Connect two Gee chairs with an joining table. Add side tables and a back panel to decrease sound overflow.

Defined by Function

Free standing occasional tables create a small public space. They effortlessly transform underutilized areas into productive public hubs—perfect for a quick touch-down meeting, a coffee break, or a collaborative workspace. No matter what the need, the Gee Collection is designed to fit your space.



PRODUCT LINE

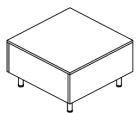

Occasional Table
• 25" W x 25"D x 17"H

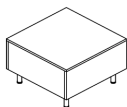

Ottoman
• 23" W x 29"D x 18"H

SPECIFICATIONS

Top Material Options

Standard Laminate
Stone top may be added for upcharge

Base Finishes

Anodized Aluminum

Powdercoats

Powdercoating may be added for an additional upcharge

Add-ons

Non-locking casters
Power

Sizing

See [price list](#) for full range of standard sizing

HAMPTON



AGATI
FURNITURE



Hampton Straight with wood veneer screen



Two basic Curves



Hampton Curve with fabric screens and casters



Metal Leg Base



Plinth Base



Hampton Curve shown in "S" configuration with wood veneer surrounds.

HAMPTON Seating Collection

Today's environments call for not only effective but creative use of space. The need for collaboration and innovation prevails, without sacrificing design and style. AGATI answers that call with its sophisticated Hampton Seating. Available in a variety of configurations, the Hampton offers adaptable form and function allowing users to sit in comfort, while meeting in style.

The basic Hampton is perfect for a casual and open space, while optional surrounds can be added to envelop users for more seclusion. Both the curved and straight Hampton can be covered in chic fabrics, backed in sleek veneers or high pressure laminate. The Hampton can rest on metal or caster legs, or a plinth base. For additional separation, custom privacy screens may be added. An ability to stand alone or build-in allows the Hampton to provide ultimate flexibility in space configuration. No matter how big or small the space, AGATI's Hampton adds abundant seating and flair to spaces everywhere.





Hampton Curves shown with wood veneer screens

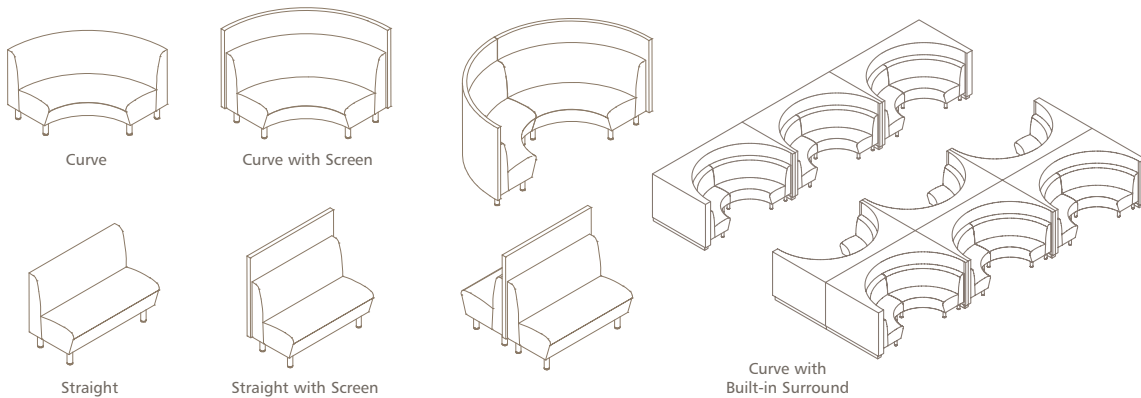

AGATI is defined by versatility. Designs combine a unique blend of aesthetics and engineering, distinguished by their eclectic styles. Inspired by the need for furniture that is both timeless and universal, AGATI is committed to the design and engineering of each and every piece.

Furniture built to last a lifetime means investing in the future. AGATI is dedicated to implementing sound environmental practices such as utilizing domestic reforested lumber, as well as reusable packaging materials. AGATI believes in helping preserve resources at no expense to the integrity of the product or the satisfaction of the customer.

Celebrated for its design. Chosen for its quality.



AGATI

1219 W Lake Street Chicago, Illinois 60607 T 312.829.1977 F 312.829.8249 www.agati.com

© 2013 AGATI, Chicago, Illinois Printed in USA 3/13_2M

HAMPTON



AGATI's popular, versatile Hampton Seating is expanding its horizons with outer curves! While the basic Hampton is perfect for casual and open spaces, the curved Hampton effectively uses space through a sophisticated and versatile design. The curved Hampton comes in 90 degree segments that can expand to a 180 degree curve to accommodate larger groups. The Hampton features a shorter seat, taller back and a pitch 10 degrees more upright than other AGATI lounge chairs, making it ideal for wherever a work sit is preferable. Both the curve and the straight Hampton can utilize additional surrounds for extra privacy wherever free standing meeting places are needed.



AGATI

HAMPTON



AGATI

www.agati.com

HAVANA



A stylish, modern alternative to the traditional lounge chair, the Havana's comfort and adaptability make it an essential. Its smaller footprint allows for comfortable lounge seating even when space is at a premium.

Havana is available in a variety of styles from a sumptuous lounge chair with wood or metal legs, to a stylish pull up, with or without upholstered arms. The Havana Pull Up is also available with a retro wood arm, or armcaps, for more institutional settings.

Visit www.agati.com to see more.

AGATI
FURNITURE

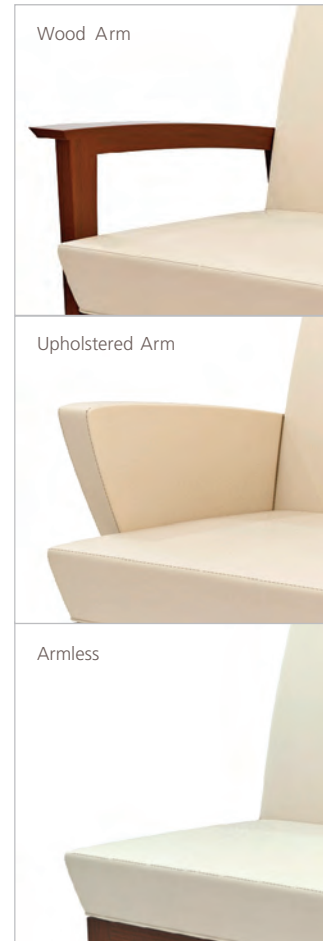

AGATI is defined by versatility. Designs combine a unique blend of aesthetics and engineering, distinguished by their eclectic styles. Inspired by the need for furniture that is both timeless and universal, AGATI is committed to the design and engineering of each and every piece.

Furniture built to last a lifetime means investing in the future. AGATI is dedicated to implementing sound environmental practices such as utilizing domestic reforested lumber, as well as reusable packaging materials. AGATI believes in helping preserve resources at no expense to the integrity of the product or the satisfaction of the customer.

Celebrated for its design. Chosen for its quality.



AGATI

RIO



Turn ordinary rooms into dynamic spaces. AGATI's Rio Collection boasts smooth curves and a contemporary yet warm style. Pick a configuration; choose your setting; the Rio Collection morphs to serve the function you need.

Seamless arches, boomerang arms, and solid wood armcaps add to the multitude of options available. With a slight upward tilt to its seat and plenty of room beneath for your feet, the Rio boosts you up after a comfortable sit. Its high back provides support keeping attention crisp. Take advantage of its versatility; take notice of its style. The Rio Collection defines today's movement.



Rio Armless



Rio Boomerang



Rio Tablet with Casters



Rio with Arm caps



Armless Lounge Chair



Rio Boomerang Arm Chair



Lounge Chair

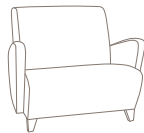

Bariatric Lounge Chair

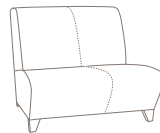

Armless Two Seat Settee

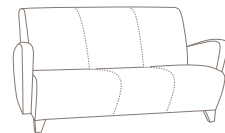

Three Seat Sofa

AGATI is defined by versatility. Designs combine a unique blend of aesthetics and engineering, distinguished by their eclectic styles. Inspired by the need for furniture that is both timeless and universal, AGATI is committed to the design and engineering of each and every piece.

Furniture built to last a lifetime means investing in the future. AGATI is dedicated to implementing sound environmental practices such as utilizing domestic reforested lumber, as well as reusable packaging materials. AGATI believes in helping preserve resources at no expense to the integrity of the product or the satisfaction of the customer.

Celebrated for its design. Chosen for its quality.

AGATI

1219 W Lake Street Chicago, Illinois 60607 T 312.829.1977 F 312.829.8249 www.agati.com

©2016 Agati, Chicago, Illinois Printed in USA 9/10_2M

RIO PULL UP



The Rio Pull Up is the perfect complement to its companion chair, the Rio Lounge. A slimmer, more agile version of the Lounge, the Rio Pull Up still features the Rio's signature curves, supported by tapered legs and a solid wood base or a new caster base option.

A stylish, casual alternative to the lounge chair, the Rio Pull Up's adaptability makes it an essential: comfortable lounge seating, contemporary guest seating, or supportive in institutional settings.

The Rio Pull Up is available as a bar or counter height stool, a children's chair and also with high back options. The Rio Pull Up is a part of the AGATI Rio Collection, which includes lounge chairs, settees, sofas and a matching ottoman. Visit www.agati.com to see more.



High Back
Boomerang



Boomerang
Arm



Rio Caster



High Back
Upholstered



Children's



Pull Up Chair



Pull Up Chair,
Armless



Pull Up Chair,
Boomerang Arm



Pull Up Chair,
High Back -
Upholstered Arm



Pull Up Chair,
High Back -
Boomerang Arm



High Stool



Childrens
Pull Up Chair



Childrens Armless
Pull Up Chair

AGATI is defined by versatility. Designs combine a unique blend of aesthetics and engineering, distinguished by their eclectic styles. Inspired by the need for furniture that is both timeless and universal, AGATI is committed to the design and engineering of each and every piece.

Furniture built to last a lifetime means investing in the future. AGATI is dedicated to implementing sound environmental practices such as utilizing domestic reforested lumber, as well as reusable packaging materials. AGATI believes in helping preserve resources at no expense to the integrity of the product or the satisfaction of the customer.

Celebrated for its design. Chosen for its quality.



AGATI

ROMA



It's a rare occasion you see a Roma chair empty. The first chair in a room to be taken, the Roma Lounge Collection offers a warm, inviting sit. Exaggerated and rotund, the Roma's curved linear arms taper to offer a comfortable embrace and ample seat room. AGATI's signature back support provides hours of comfort whether lounging or studying.

Built for institutional use, the Roma Collection's strength is a perfect foil to its pleasing and abundant appeal. Satin nickel or chrome finish cast metal feet cap off each piece. The Roma Collection also includes a settee, sofa and matching ottoman. Visit www.agati.com to view more.

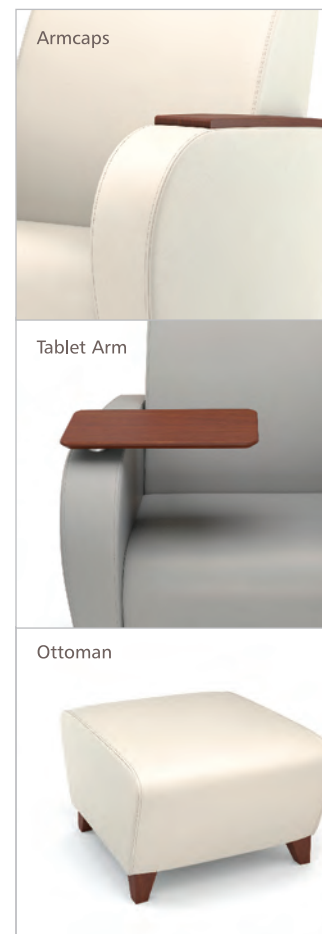

Roma Settee



Lounge with Armcaps



Lounge Chair

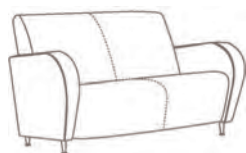

Two Seat Settee

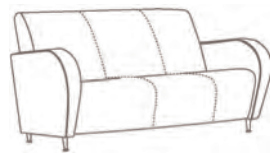

Three Seat Sofa



Ottoman

AGATI is defined by versatility. Designs combine a unique blend of aesthetics and engineering, distinguished by their eclectic styles. Inspired by the need for furniture that is both timeless and universal, AGATI is committed to the design and engineering of each and every piece.

Furniture built to last a lifetime means investing in the future. AGATI is dedicated to implementing sound environmental practices such as utilizing domestic reforested lumber, as well as reusable packaging materials. AGATI believes in helping preserve resources at no expense to the integrity of the product or the satisfaction of the customer.

Celebrated for its design. Chosen for its quality.



AGATI

1219 W Lake Street Chicago, Illinois 60607 T 312.829.1977 F 312.829.8249 www.agati.com

©2016 AGATI, Chicago, Illinois Printed in USA 8/12_1M

KEYSTONE



A keystone is defined as the central supporting element of a whole. And like its name, the AGATI Keystone Collection serves as a building block. Start with a simple lounge chair, and as necessary, build the optimal chair using the Keystone's abundant options.

Choose solid wood arm caps for a clean, simple corporate use. Add casters or a tablet arm for institutional settings. No matter what its use, the Keystone's solid steel frame construction makes it a mainstay.

The Keystone Collection comes fully upholstered with arched arms and back. With its sturdy construction and multifaceted capabilities, the Keystone will hold its place in any room, for many years to come.



Metal Feet



Wood Feet



Caster Feet

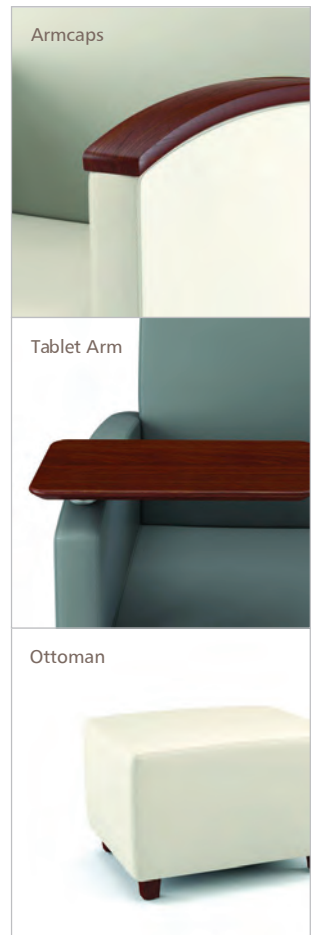



Lounge Chair



Lounge Chair
with Tablet Arm

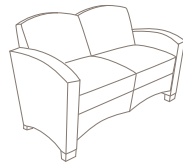

Two Seat Settee

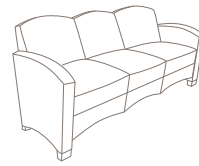

Three Seat Sofa



Ottoman

AGATI is defined by versatility. Designs combine a unique blend of aesthetics and engineering, distinguished by their eclectic styles. Inspired by the need for furniture that is both timeless and universal, AGATI is committed to the design and engineering of each and every piece.

Furniture built to last a lifetime means investing in the future. AGATI is dedicated to implementing sound environmental practices such as utilizing domestic reforested lumber, as well as reusable packaging materials. AGATI believes in helping preserve resources at no expense to the integrity of the product or the satisfaction of the customer.

Celebrated for its design. Chosen for its quality.

AGATI

1219 W Lake Street Chicago, Illinois 60607 T 312.829.1977 F 312.829.8249 www.agati.com

©2016 AGATI, Chicago, Illinois Printed in USA 11/10_2M

TUXEDO



The Tuxedo chair is long on style, short on frill. This fresh and simple lounge chair is accented by streamlined angles and modern lines. Constructed with a steel frame, the Tuxedo will provide comfort for a lifetime.

The Tuxedo is fully upholstered with square side panels. Its many options include solid wood, satin nickel or caster feet. Tailor any Tuxedo by choosing from solid wood arm caps, tablet arm option or matching ottoman. Visit www.agati.com to see more.



Caster feet



Wood feet

Armcaps



Tablet Arm



Ottoman





Lounge Chair
Metal Feet



Lounge Chair
with Tablet Arm
Wood Feet

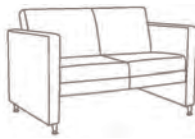

Two Seat Settee
Metal Feet

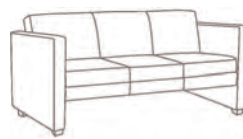

Three Seat Sofa
Wood Feet



Ottoman

AGATI is defined by versatility. Designs combine a unique blend of aesthetics and engineering, distinguished by their eclectic styles. Inspired by the need for furniture that is both timeless and universal, AGATI is committed to the design and engineering of each and every piece.

Furniture built to last a lifetime means investing in the future. AGATI is dedicated to implementing sound environmental practices such as utilizing domestic reforested lumber, as well as reusable packaging materials. AGATI believes in helping preserve resources at no expense to the integrity of the product or the satisfaction of the customer.

Celebrated for its design. Chosen for its quality.



AGATI

1219 W Lake Street Chicago, Illinois 60607 T 312.829.1977 F 312.829.8249 www.agati.com

©2016 AGATI, Chicago, Illinois Printed in USA 8/12_1M

Material & Finish Disclaimer

* Please Note:

Digital representations may vary. For best accuracy, please request a sample.

Corian Solid Surface

Agati uses Group 1 as standard, but Additional group options are available.

Wilsonart and Panolam Plastic Laminate

Edge Banding may vary between Charter, Doelken, or Rehau depending on product availability.

Daltile Engineered Stone

Agati uses Grade 2 as standard, but additional grade options are available.

Metal Finishes

Standard finishes vary by product. Please contact us if your preferred finish isn't offered as a standard.

Wood Finishes

Due to natural variation in wood species and grain, final finishes may differ in appearance.

Standard - Adapt Acoustical Panel

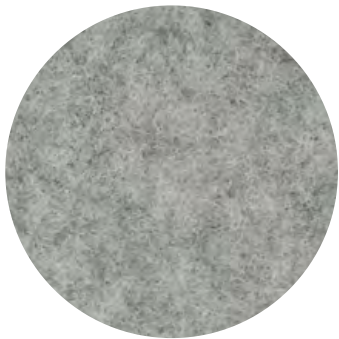

Greige

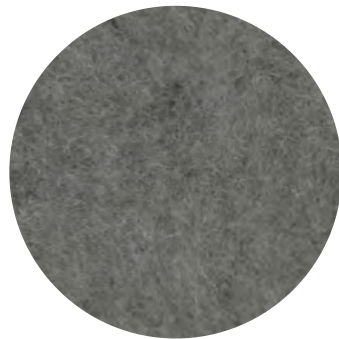

Fossil

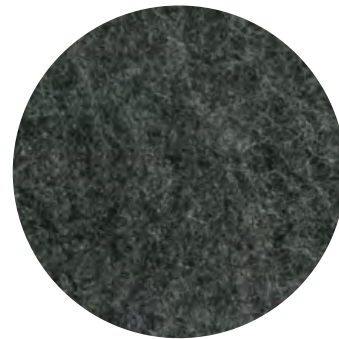

Slate



Tar

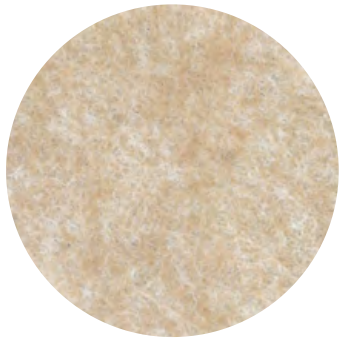

Linen

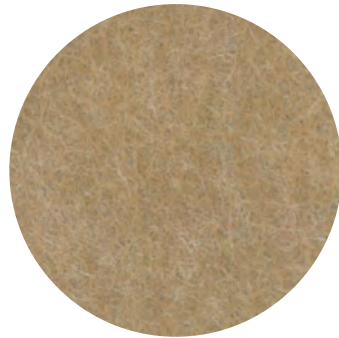

Ecu

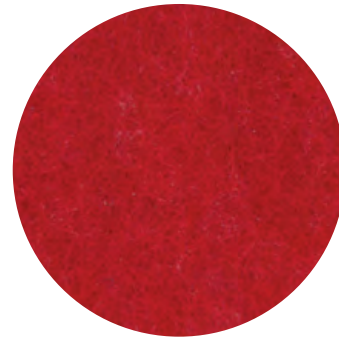

Ochre

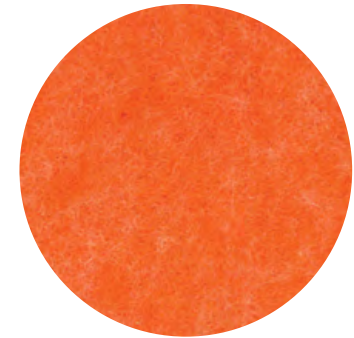

Mandarin



Sunshine

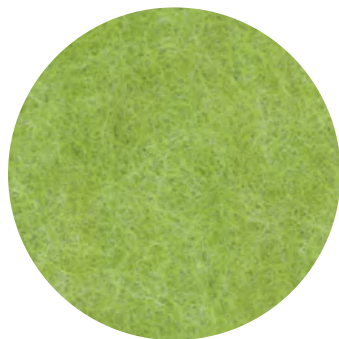

Grass

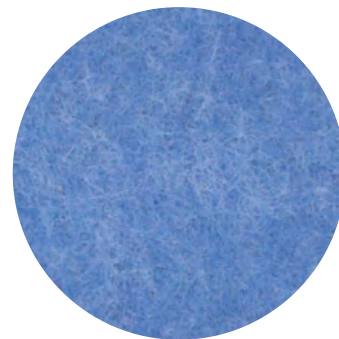

Sky

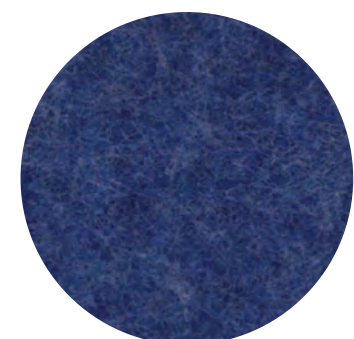

Cobalt

Standard - Framework Acoustical Panel



Marble



Oat

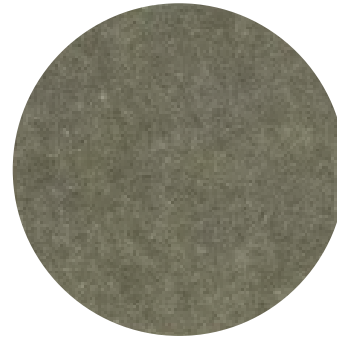

Stone

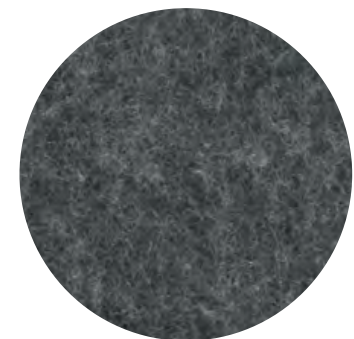

Grey

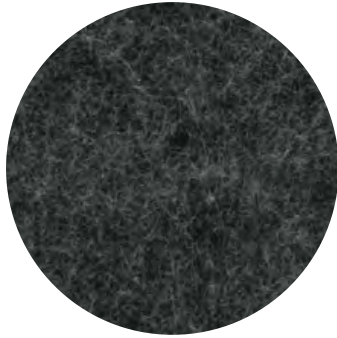

Pepper

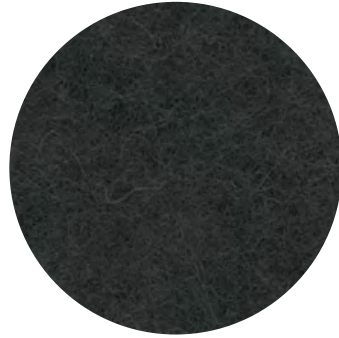

Charcoal



Red

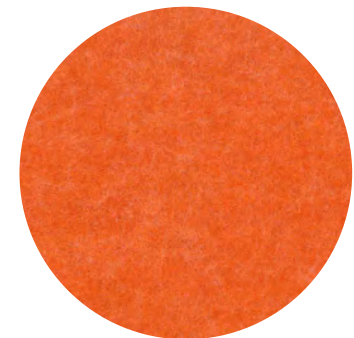

Orange

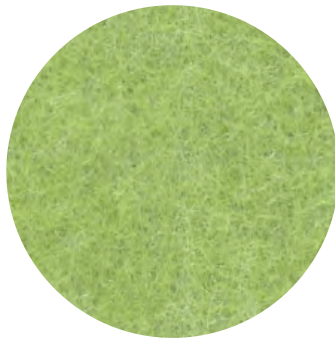

Pear

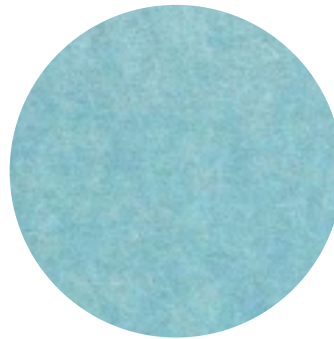

Teal

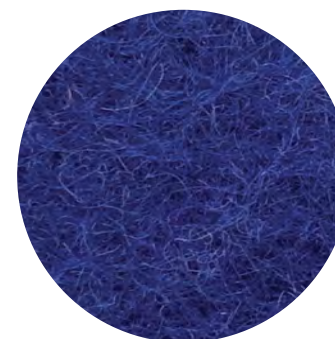

Navy

Standard - Cove Acoustical Panel

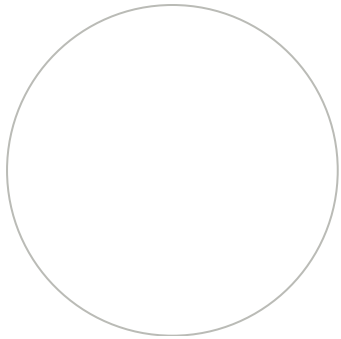

Swan

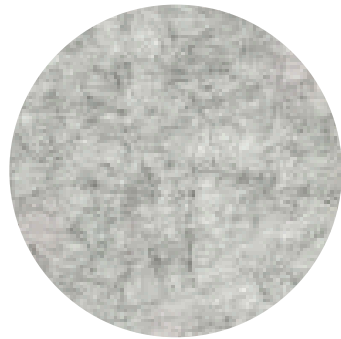

Mottled

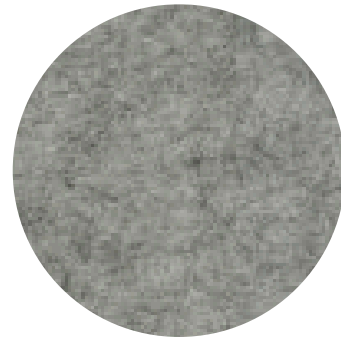

Elephant

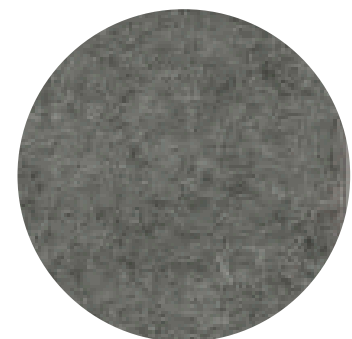

Dolphin

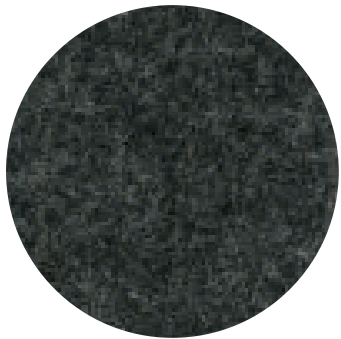

Rhino



Raven

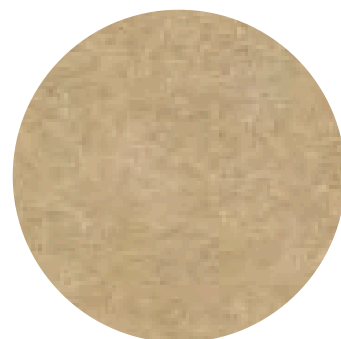

Straw

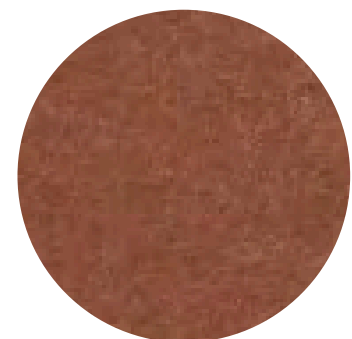

Terracotta

Standard - Cove Acoustical Panel

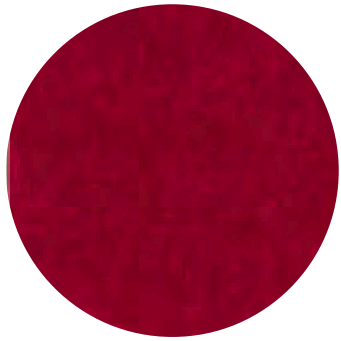

Cherry

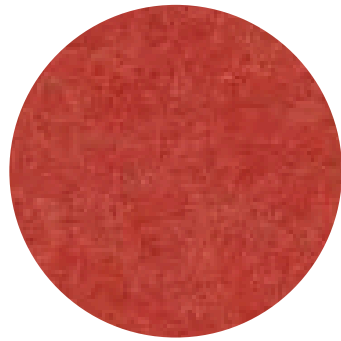

Coral

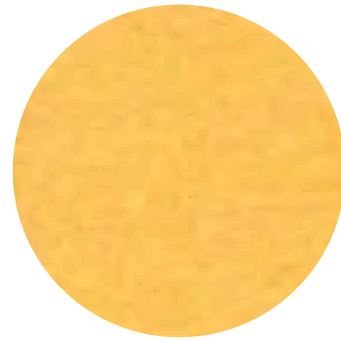

Canary

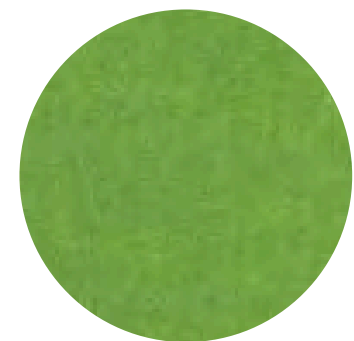

Pea

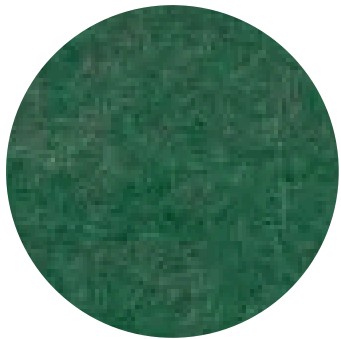

Emerald

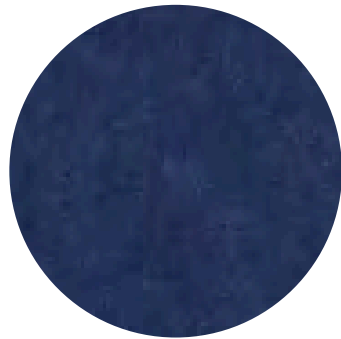

Lapis

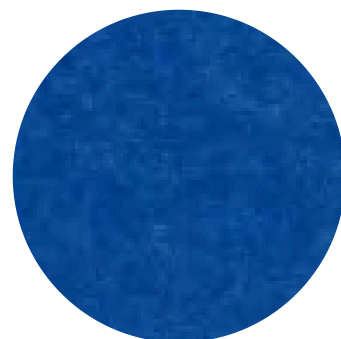

Royal Blue

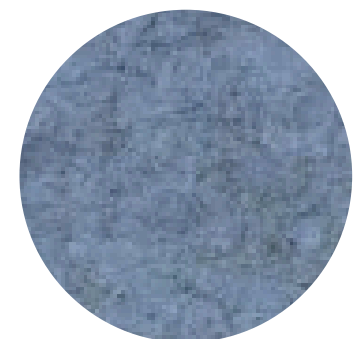

Baby Blue

Standard - Daltile Engineered Stone - Grade 2



Morning Frost

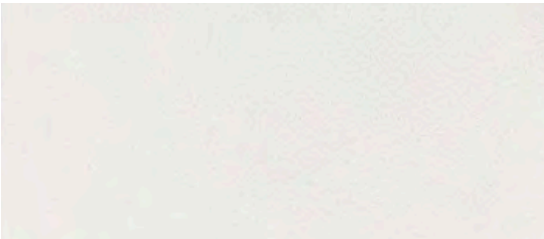

Lucent White



Woven Wool

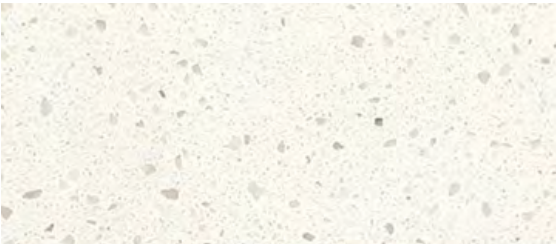

Simply White



Fresh Linen



Chipped Ice

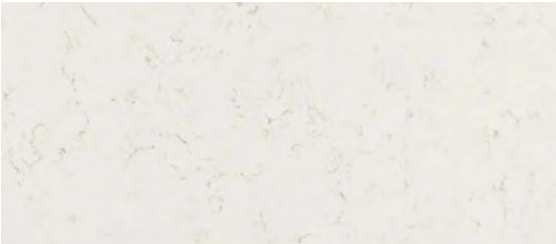

Niagara



Carrara Pisa



Nightfall



Ash Grey



Concrete Grey

Standard - Corian Solid Surface - Group 1



Glacier White



Cameo White

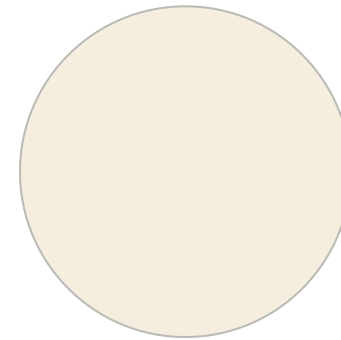

Bisque



Linen



Pearl Gray

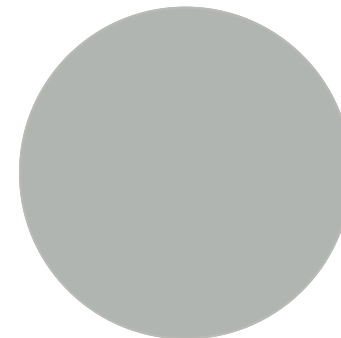

Silver Gray

Standard - 3Form



Material:
Varia Clear

Finish:
Satin

Thickness:
3/8"

Description:
An etched finish that provides diffusion and privacy without an overly frosted appearance.

Standard - Powder Coats

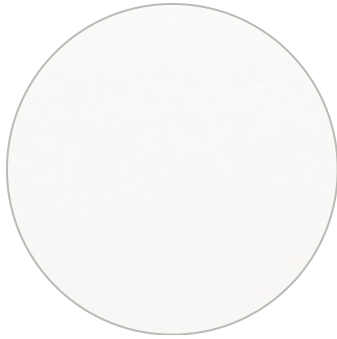

White



Light Tone



Metallic Silver



Argento 308



Gold



Highland Bronze

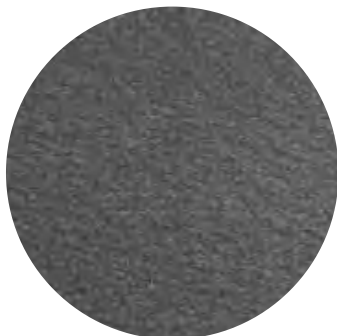

Mist Grey Wrinkle



Dark Tone



Black Fine Texture

Available Metal Finish Options by Product

PRODUCTS	Argento 308	Black Fine Texture	Bronze	Captive Blue *	Chrome	Dark Tone	Gold	Light Tone	Metallic Silver	Mist Gray Wrinkle	Polished Aluminum	Spring Purple *	Tree Frog *	White
Adapt Collection		✓							✓					
Altezza Stool		✓							✓					
Antrim Collection	✓	✓	✓			✓	✓	✓	✓	✓				✓
Cove Carrel		✓							✓					
Cubit	✓	✓	✓	✓		✓	✓	✓	✓	✓		✓	✓	✓
Departures		✓							✓					
Elements Table	✓	✓	✓			✓	✓	✓	✓	✓				✓
Etta Lounge											✓			
Fan Chair					✓									
Framework	✓	✓	✓			✓	✓	✓	✓	✓				✓
Manifest Collection	✓	✓	✓			✓	✓	✓	✓	✓				✓
Metal Base Tables	✓	✓	✓		✓	✓	✓	✓	✓	✓				✓
Orb 4 Leg		✓							✓					✓
Orb Disc Base									✓					
Orb X Base											✓			
Power Bar Collection	✓	✓	✓			✓	✓	✓	✓	✓				✓
Sensi					✓				✓					
Vera Collection									✓					

* Indicates specialty finish

Standard finishes vary by product. Please contact us if your preferred finish isn't offered as a standard.

Digital representations may vary. For best accuracy, please order a physical sample.

Standard - Wood Finishes



Kensington Maple



Solar Oak

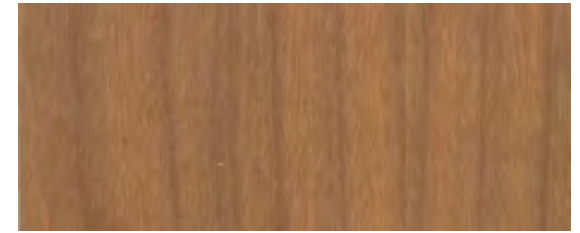

Tuscan Walnut



Amber Cherry



Biltmore Cherry

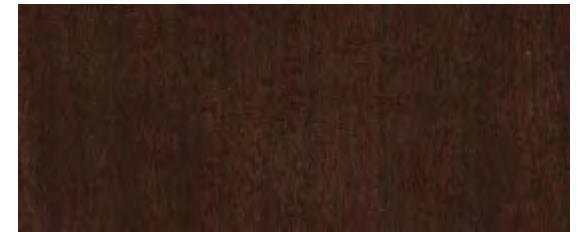

Brighton Walnut

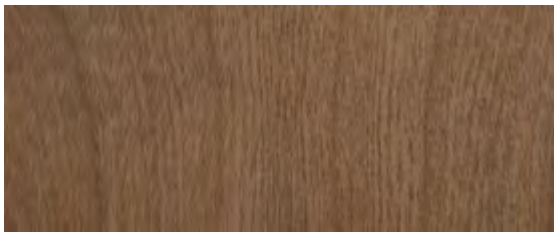

River Cherry

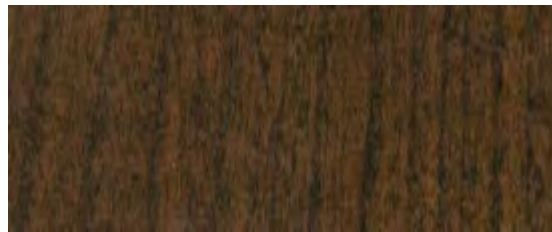

Montana Walnut



NeoWalnut

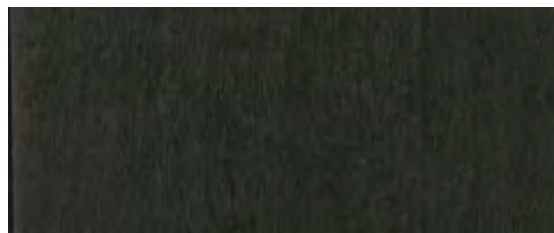

Ebony Recon

Standard - Sensi Laminates



Stop Red



Clementine



Chrome Yellow



Vibrant Green



Spectrum Blue



Cassis



White



Oyster Gray



Earth

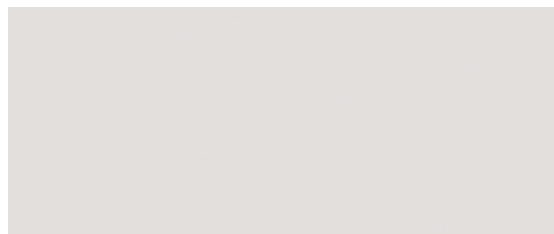

Zen Gray



Mouse

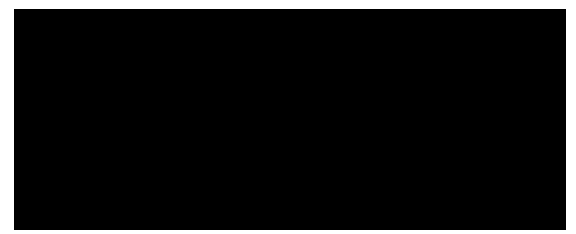

Black

Standard - Sensi Laminates



Sand Maple



Bleached Legno

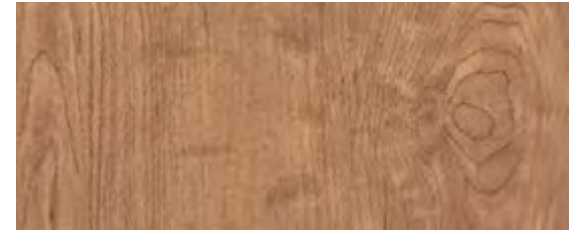

Cognac Maple

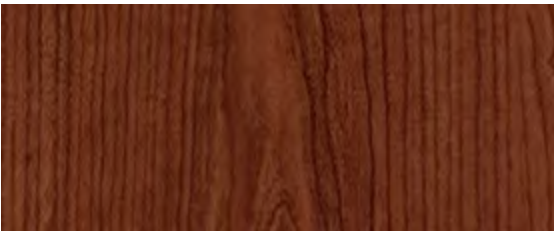

Select Cherry



Cocoa Maple



Blackened Legno

Standard - Panolam Laminates



Hardrock Maple WM791-SD
Charter Industries PTWM791



Scandia Maple WM5577-SD
Charter Industries NWM5577E



Honey Maple WM951-SD
Charter Industries PTWM951



Carmel Sagawood WM8350
Rehau CP40103

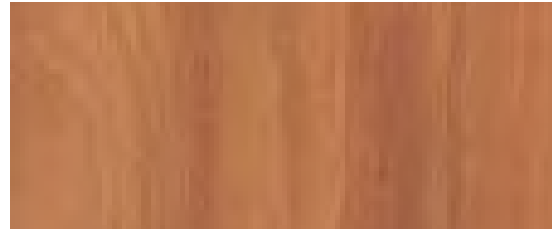

Oiled Cherry WC421-SD
Charter Industries PTWC421

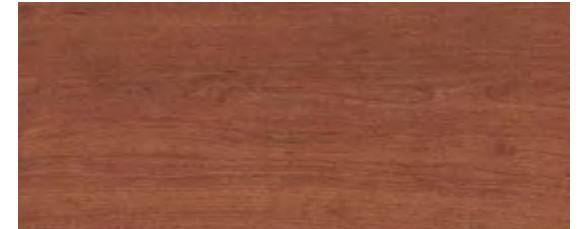

Spice Walnut WW561-SD
Charter Industries PTWW561



Sovereign Cherry W8325-T
Charter Industries NW8325



Blossom Cherry WC5581-SD
Rehau CP40899



Regency Mahogany W8352-SD
Charter Industries NW8352

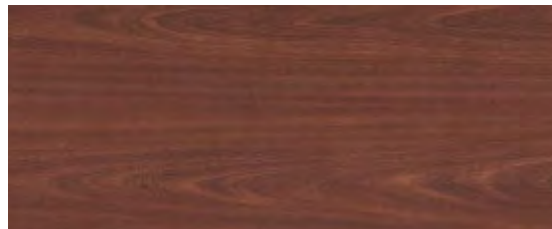

Formal Mahogany WY031-SD
Charter Industries NW8325

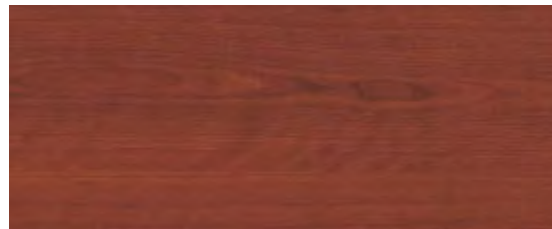

Crown Cherry W8294-T
Charter Industries NW8294

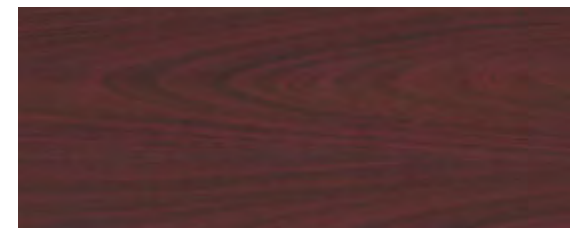

Jewel Mahogany WY351-SD
Rehau CP40738

Standard - Panoram Laminates



Macchiato WF0011T
Charter Industries NMWF0011



Kingsley WW011-SD
Charter Industries PTWW011



Stout Walnut WW3100-T
Charter Industries NWW3100

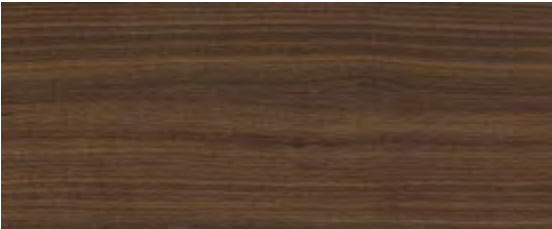

Walnut Grove WW050-SD
Charter Industries PTWW050

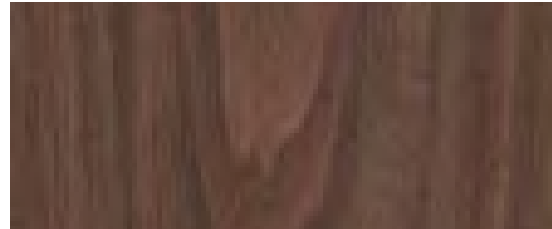

Gunstock Savoy Walnut WW971-SD
Charter Industries PTWW971

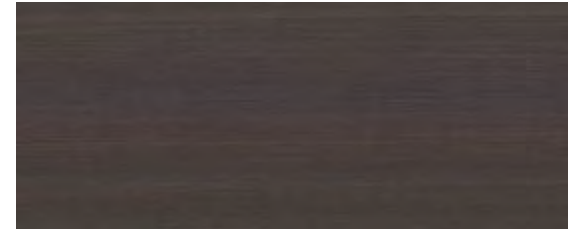

Valencia Teak WT0003-SD
Charter Industries NWT0003PV



Wild Oats Matix MR7002-T
Charter Industries NMR7002T

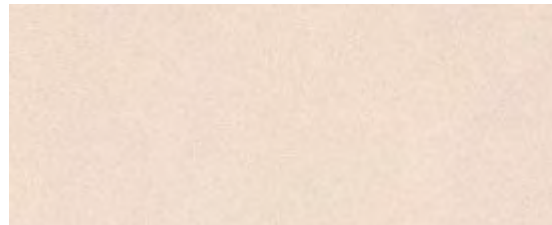

Straw Matrix MR2006-T
Charter Industries NMR2006

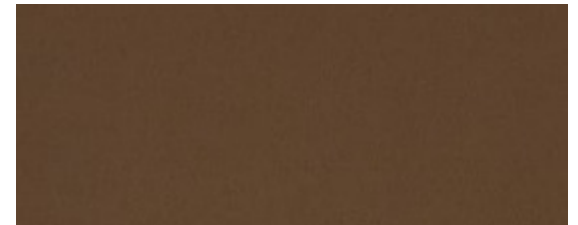

Vous Fawn VS2001-T
Charter Industries NVS2001

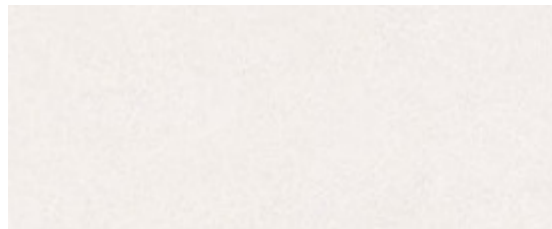

White Essence ES7001-T
Charter Industries NES7001

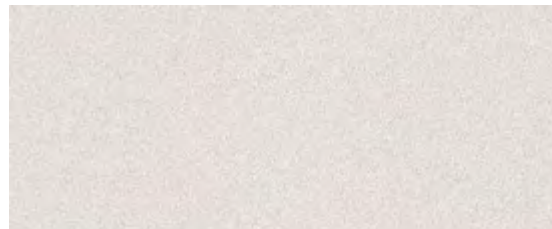

Grey Matrix MR6001-T
Charter Industries NMR64T

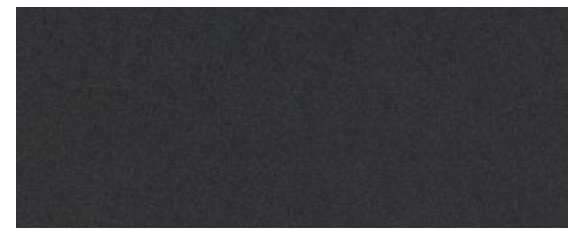

Charcoal Matrix MR6002-T
Charter Industries NMR62T

Standard - Panolam Laminates

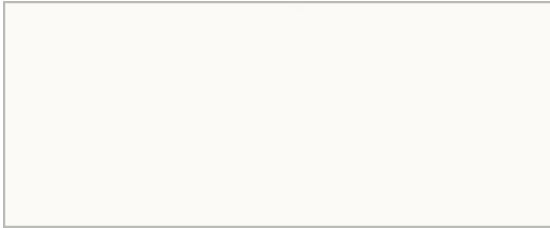

Winter White SW836-SD
Doellken 2002



Dolphin Gray SG246-SD
Doellken 2426



Black SE101-SD
Charter Industries PTAE100



Primary Red SR520-SD
Charter Industries PTSR520



Liberty Red S-1027-SD
Charter Industries NS1027



Bittersweet S0312-SD
Charter Industries PTS0312



Primary Yellow SY914-SD
Charter Industries PTSY914



Springtime SV709-SD
Charter Industries PTSV709



Fresh Cut Grass SV750-SD
Charter Industries PTSV750



Patriot Blue S-3048-T
Charter Industries NS3048



Navy Blue SB007-SD
Rehau C500075

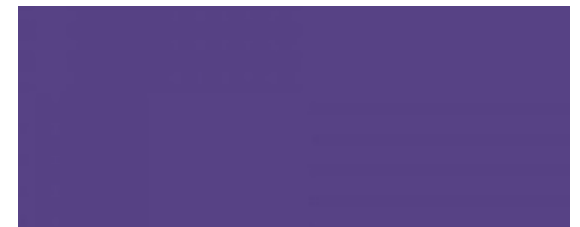

Tutti Frutti SP414-SD
Charter Industries PTSP414

Standard - Wilsonart Laminates - Solids

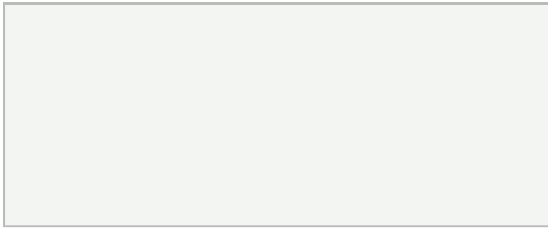

Frosty White 1573-60
Rehau C100033

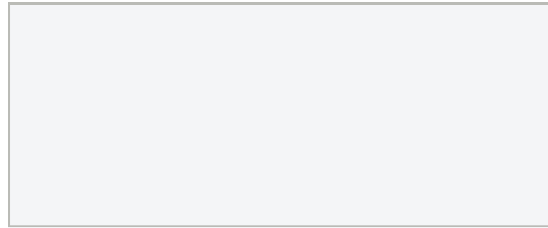

Designer White D354-60
Charter Industries WD354

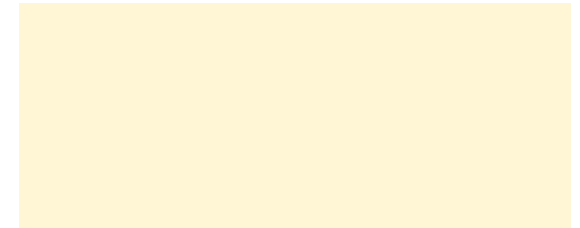

Antique White 1572-60
Doellken 9366

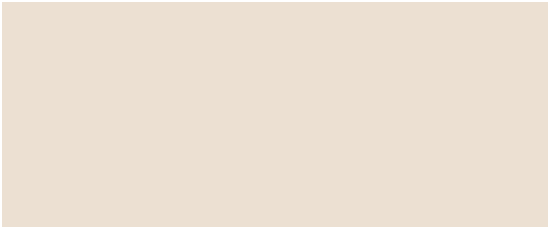

Wallaby D439-60
Rehau C200087

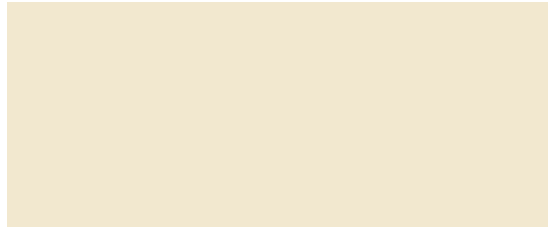

Natural Almond D30-60
Doellken 2114

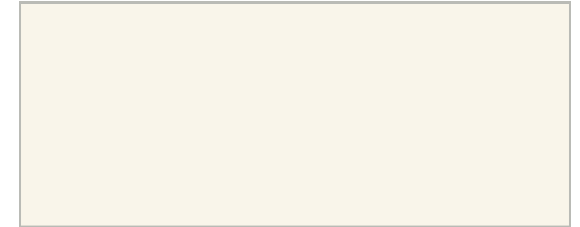

Alabaster D431-60
Rehau C00187

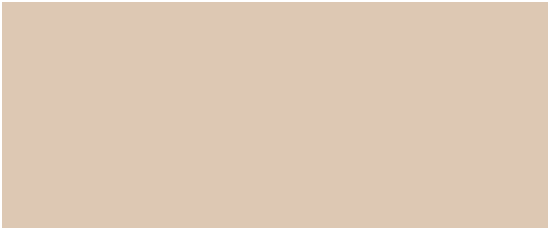

Khaki Brown D50-60
Doellken 2240

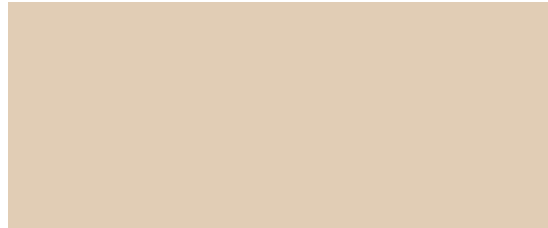

Beige 1530-60
Rehau C200063

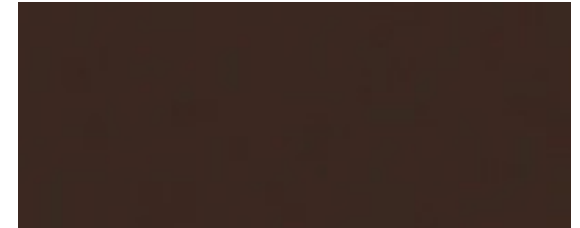

Coffee Bean D495-60
Rehau C400086

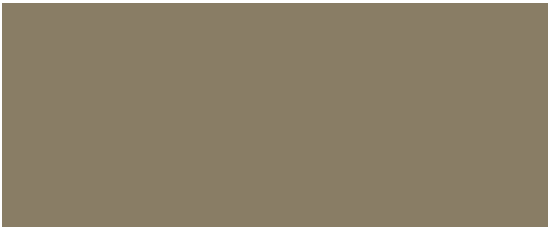

Shadow D96-60
Doellken 6397

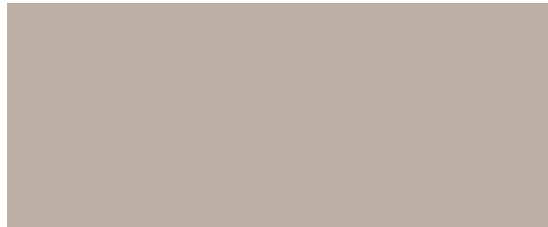

Pepperdust D327-60
Doellken 2495

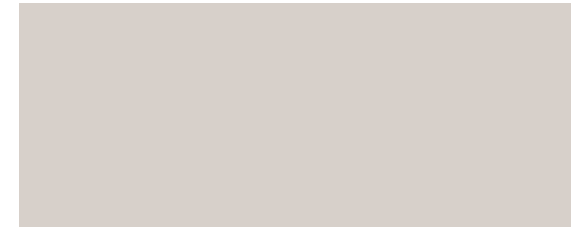

Grey 1500-60
Doellken 2422

Standard - Wilsonart Laminates - Solids

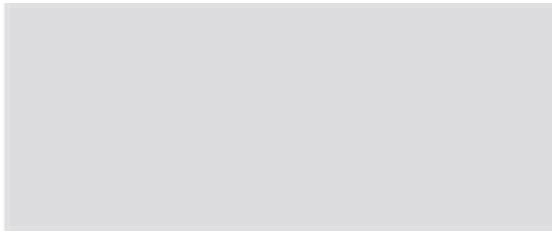

Crystal D388-60
Doellken 2145



Platinum D315-60
Rehau C600063



Fashion Grey D381-60
Rehau C600004



Dove Grey D92-60
Doellken 2426



Cement D503-60
Charter WD503



Pewter D73-60
Charter Industries WD73



North Sea D90-60
Doellken 2477



Slate Grey D91-60
Doellken 2431

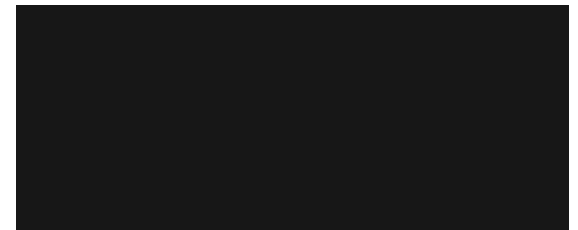

Black 1595-60
Doellken 2416



Port D14-60
Rehau C300036



Hunter green D79-60
Rehau C700067



Indigo D379-60
Charter Industries WD379

Standard - Wilsonart Laminates - Solids



Orange Grove D501-60
Charter Industries WD501



Island D498-18 Charter
Industries WD498



Hollyberry D307-60
Charter Industries WD307



Atlantis D25-60
Charter Industries WD25



Lapis D417-60
Charter Industries WD417



Ocean D502-18
Charter Industries WD502

Standard - Wilsonart Laminates - Patterns



White Nebula 4621-60
Rehau CP0077



Grey Nebula 4622-60
Charter Industries W4622



Graphite Nebula 4623-60
Doellken 6623



Neutral Glace 4143-60
Charter Industries W4143



Grey Glace 4142-60
Rehau CP10031



Bronze Legacy 4656-60
Rehau CP20044

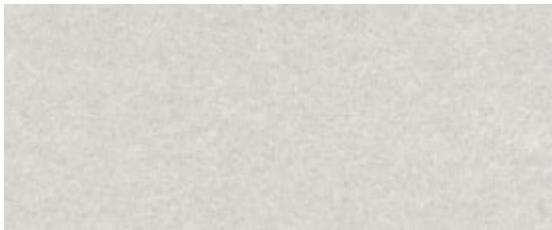

Shadow Zephyr 4857-60
Charter Industries W4857

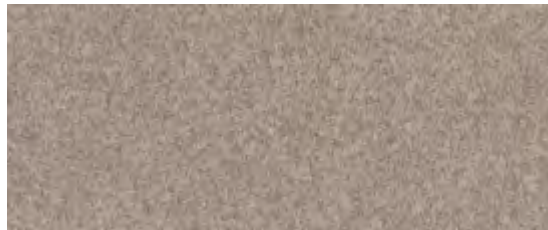

Canyon Zephyr 4842-60
Charter Industries W4842



Twilight Zephyr 4845-60
Charter Industries W4845



Crisp Linen 4942-38
Charter Industries W4942



Flax Linen 4990-38
Charter Industries W4990



Casual Linen 4944-38
Charter Industries W4944

Standard - Wilsonart Laminates - Woodgrains



Beigewood 7850-60
Rehau CP20567



Manitoba Maple 7911-60
Rehau CP20016



Limber Maple 10734-60
Rehau CP20606



Kensington Maple 10776-60
Doellken 4469



Fusion Maple 7909-60
Doellken 30364



Bannister Oak 7806-60
Charter Industries W7806

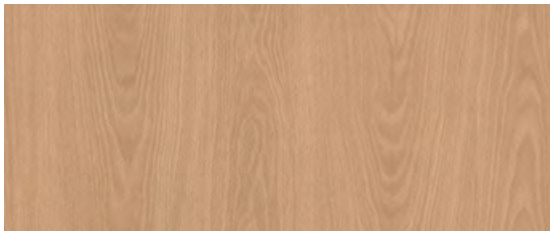

New Age Oak 7938-38
Charter Industries W7938

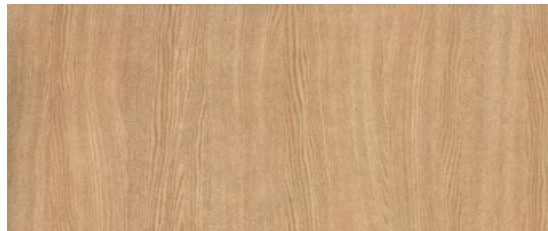

Natural Rift 7954-38
Charter Industries W7954



Solar Oak 7816-60
Rehau CP20599



Monticello Maple 7925-38
Doellken 4894



Huntington Maple 7929-38
Rehau CP40603



Wild Cherry 7054-60
Doellken 3921

Standard - Wilsonart Laminates - Woodgrains



Tuscan Walnut 7921-38
Rehau CP40466



Amber Cherry 7919-78
Doellken 8796YS



Biltmore Cherry 7924-07
Doellken 4893



River Cherry 7937-38
Doellken 5891



Brazilwood 7946-38
Rehau CP20118

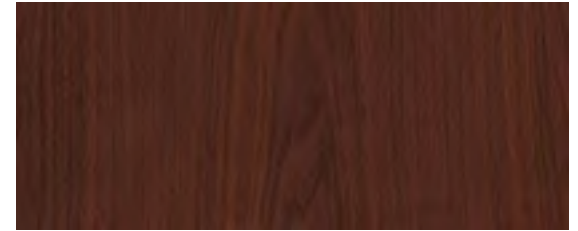

Brighton Walnut 7922-07
Rehau CP40223



Fonthill Pear 10745-60
Doellken 4997



Natural Pear 7061-60
Rehau CP40065

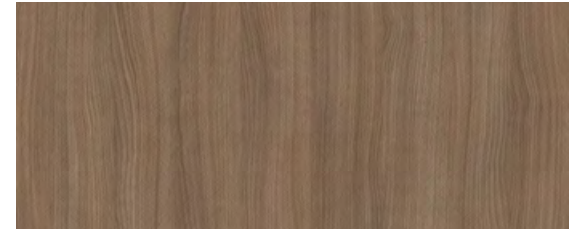

Neowalnut 7991-38
Charter Industries W7991

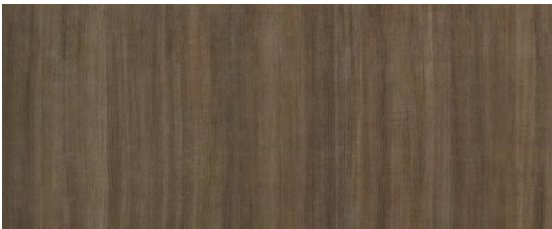

Studio Teak 7960-18
Charter Industries W7960

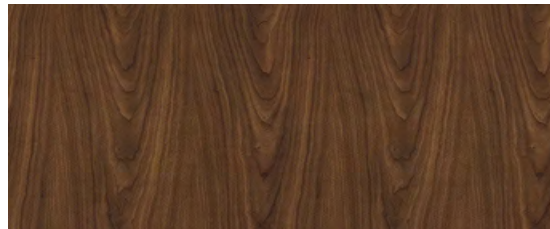

Montana Walnut 7110-78
Rehau CP40613

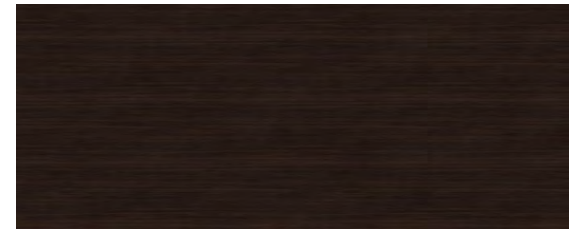

Ebony Recon 7997-38
Charter Industries W7997

Standard - Wilsonart Laminates - Premium Woodgrains



English Oak 7885-78
Rehau CP40095



Shaker Cherry 7935-07
Rehau CP40108



Mambo 7948-07
Rehau CP40415

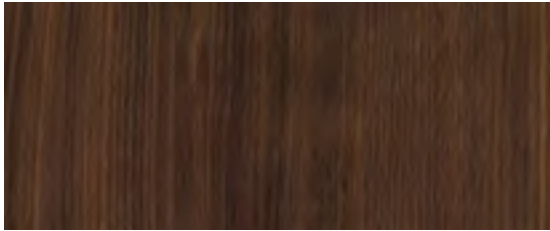

Columbian Walnut 7943-07
Doellken 5963S

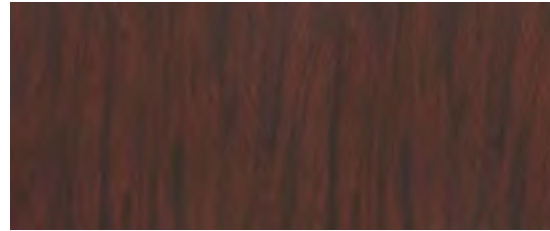

Figured Mahogany 7040-78
Doellken 3796

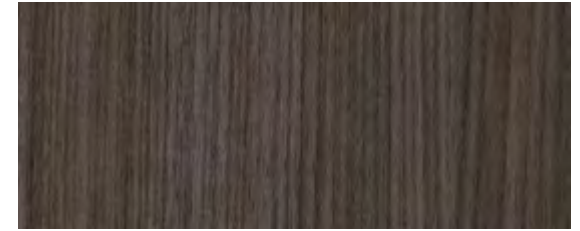

Skyline Walnut 7964-12
Charter Industries W7964

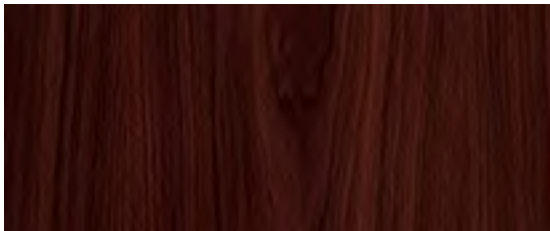

Empire Mahogany 7122-07
Doellken 3796

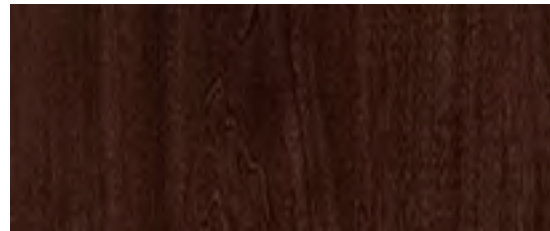

Cocobala 7942-07
Rehau CP40416

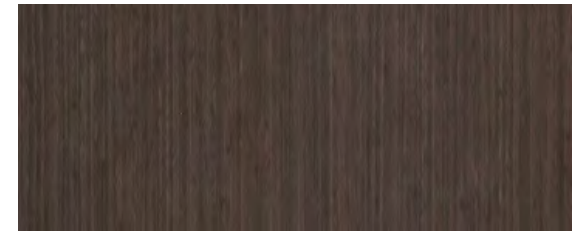

Asian Night 7949-18
Charter Industries W7949



Windsor Mahogany 7039 -78
Doellken 3789

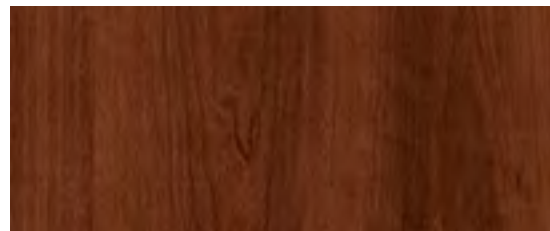

Williamsburg Cherry 7936-07
Rehau CP40108

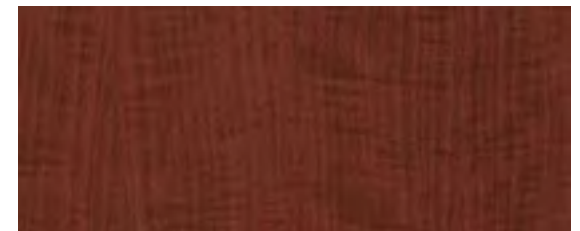

Versailles Anigre 7923-07
Rehau CP40602